

# Majvest<sup>®</sup>

**System Guidelines**  
for Mechanically-Attached  
Water-Resistive Barrier  
and Air Barrier Assemblies





# Contents

<b>Part 1 System Overview</b>	p. 4
1.1 Introduction	
1.2 Components	
1.3 Usage and Substrate Matrix	
<b>Part 2 Air Barrier Design Considerations</b>	p. 6
<b>Part 3 Installation Parameters</b>	p. 7
3.1 Preconstruction	
3.2 Substrate Preparation	
3.3 Site Conditions	
3.4 Cladding Assembly Requirements	
3.5 Storage	
<b>Part 4 Installation</b>	p. 8
4.1 Tools Required	
4.2 Overlap Requirements	
4.3 Sheet Installation Process	
4.4 Fastening Schedules	
4.5 Addressing Air Leakage from Fasteners	
<b>Part 5 Construction Details</b>	p. 13
<b>5.1 Penetrations</b>	p. 13
5.1.1 Round Penetrations	
5.1.2 Square Penetrations	
5.1.3 Electrical Wires	
<b>5.2 Fenestrations</b>	p. 16
5.2.1 WRB Preparation: Cut-Out Method	
5.2.2 WRB Preparation: Target Method	
5.2.3 Pre-Flashing	
5.2.4 Back-dam Waterproofing	
5.2.5 Sill Pan Boot Creation	
5.2.6 Window Installation: Flanged	
5.2.7 Window Installation: Non-Flanged	
5.2.8 Post-Window WRB Integration: Cut-Out Method	
5.2.9 Post-Window WRB Integration: Target Method	
5.2.10 Interior Air-seal	
<b>5.3 Field WRB Details</b>	p. 28
5.3.1 Cross-Cavity Flashing	
5.3.2 Base of Wall at Grade	
5.3.3 Cantilevered Floor	
5.3.4 Parapet at Low-Slope Roof	
5.3.5 Air Barrier Transition at Eave (Vented Roof)	
5.3.6 Cladding Attachments	
5.3.7 Damage Repair	
<b>Part 6 SIGA Reliability</b>	p. 35
6.1 Product Performance and Limitations	
6.2 Guidelines	
6.3 Technical Product Properties	
6.4 10-Year Limited Warranty	
<b>Part 7 Product Information</b>	p. 36
<b>SIGA Company Values</b>	p. 42

# PART 1 System Overview

---

## 1.1 INTRODUCTION

SIGA Majvest® is a commercial-grade, vapor-permeable, mechanically-fastened sheet membrane designed to meet or exceed industry standards for a weather resistive barrier (WRB) and air-barrier (AB) as prescribed by the IBC and IECC.

SIGA Majvest has been evaluated to meet and exceed the Air Barrier Material and Type 1 Sheathing Membrane functional requirements of the NBC 2015.

These guidelines are intended to portray the broad installation practices required to achieve a combined WRB and AB assembly in residential and commercial buildings of less than 6 stories using SIGA Majvest, for the convenience of contractors, specifiers, and other construction professionals. It is the responsibility of the design Authority of Record to confirm or adapt these guidelines to support project specific parameters and local code compliance.

For procedures and conditions beyond the scope of this document, or for assistance with modifying specific details, please consult your local licensed design professional or SIGA representative.

## 1.2 COMPONENTS

Use the SIGA products below to complete a resilient, above-grade exterior building envelope. Additional Product data can be found at the end of these guidelines, or at <https://siga.swiss>.

### **Majvest**

mechanically-attached vapor-permeable water-resistive barrier and air barrier membrane: 59", 118" widths

### **Wigluv® 60**

highly elastic, semi-permeable tape for sealing membrane overlaps and penetrations: 2.4" wide

### **Wigluv 100/150/230**

low-profile, semi-permeable flashing for window and door installation: 4", 6", and 9" widths

### **Wigluv 20/40**

elastic, semi-permeable tape with tear-resistant, offset split backing, for sealing inside corners: 2.4" wide

### **Fentrim IS 20**

pre-folded, fleece-backed interior tape for air-sealing windows and doors: 3", 4", and 6" widths

### **Dockskin®**

penetrating primer for concrete and other porous substrates: 2.2 lb bottle



### 1.3 USAGE AND SUBSTRATE MATRIX

	MEMBRANE		TAPES			
	Majvest 3m	Majvest 1.5m	Wigluv 60	Wigluv 100 • 150 • 230	Wigluv 20/40	Fentrim IS 20
RECOMMENDED USAGE						
Field of Wall (WRB)						
Membrane Overlap Sealing						
Pre-Stripping (Air Barrier continuity)						
Penetrations						
Fenestrations						
Fenestrations (Interior Air-Sealing)						
Substrate Transitions						
Expansion Joint						
Electrical Wires						
Damage Repair to Air Barrier						
SUBSTRATES WITH RECOMMENDED MINIMUM OVERLAP						
Unfinished Wood / Plywood / OSB			1"	1"	1"	1"
Wood Fiberboard				2" *Dockskin		2" *Dockskin
Exterior Gypsum			1"	1"	1"	1"
Metal			1"	1"	1"	1"
Hard Plastics / Vinyl			1/2"	1/2"	1/2"	1/2"
Electrical Wires			1/2"	1/2"	1/2"	1/2"
Rigid Insulation EPS / XPS / PU			1"	1"	1"	1"
Concrete				2" *Dockskin		2"
Majvest 3m / 1.5m	4"	4"	1"	1"	1"	1"

# PART 2 Air Barrier Design Considerations

Majvest membrane will support creation of a durable exterior air-barrier wall assembly, in addition to performing as a robust weather-resistive barrier.

Completing a whole-building air-tightness approach (Fig. 1) requires maintaining this continuous and sealed layer, as it transitions in, out, and around structural components, penetrations, and claddings. Proper detailing, construction sequencing, and material selection are essential to achieving this additional air-tight attribute.

Identifying this air-barrier path visually in project drawings can greatly improve coordination and quality control across different scopes of work.

## Key Air Barrier Details

- Ⓐ Wall to roof
- Ⓑ Membrane overlaps
- Ⓒ Fenestrations
- Ⓓ Cladding attachments
- Ⓔ Flashing integration
- Ⓕ Cantilevered floors
- Ⓖ Penetrations
- Ⓗ Foundation to wall

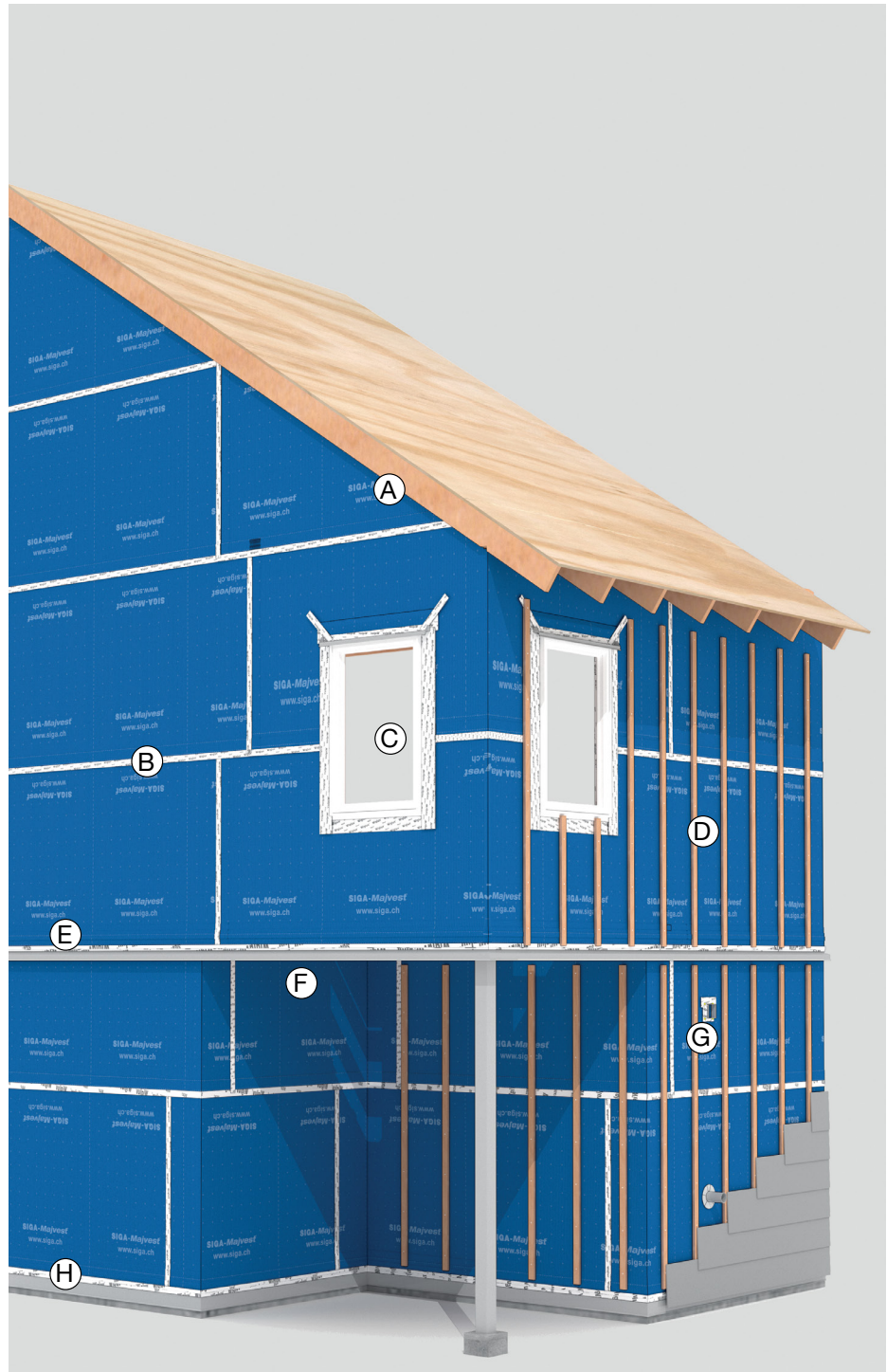

Figure 1

# PART 3 Installation Parameters

---

## 3.1 Preconstruction

Air-barrier continuity requires collaboration between everyone involved on the building project. For best results, convene a preconstruction meeting with all parties relevant to building envelope construction, before proceeding with WRB installation.

- construct a project-specific mockup to manage the constructability, compatibility, and sequencing of different materials and processes
- full curing of all sealants and subsequent water intrusion and air-tightness testing is recommended
- ensure that all building components e.g. windows, doors, penetrations, etc. are installed in accordance with the manufacturer's instructions

## 3.2 Substrate Preparation

- substrate should be smooth, dry, and free of debris, frost, grease, contaminants and sharp edges
- mechanical fasteners should be installed flush to the substrate surface
- masonry joints should be struck flush

## 3.3 Site Conditions

- for fully-closed wall facade installations only: not for use in roofing or below-grade assemblies, or wall facades having permanent UV exposure
- recommended maximum building height is 65 ft / 20 m
- maximum UV exposure of installed Majvest is 3 months (IECC Climate Zones 3 to 8)
- cover Majvest as soon as practical after installation

## 3.4 Cladding Assembly Requirements

- minimum 3/8" (10mm) airspace is required between installed Majvest and all cladding types, utilizing methods such as:
  - > mold-, rot- and compression-resistant vertical furring
  - > 3D dimpled sheet or mesh mat
- stucco and manufactured stone facades require two independently installed WRB layers in addition to 3/8" minimum air space
  - > comprise two layers either entirely of Majvest, or one layer of Grade D building paper over one layer of Majvest
  - > install two layers so that each layer provides a separate continuous drainage plane
  - > install flashings to drain water between the layers

## 3.5 Storage

- store in cool, dry, UV-protected location in original packaging
- no long-term storage limitation, when above conditions are maintained
- Dockskin ONLY: protect liquid from freezing; 18 month shelf-life from original date of sale

# PART 4 Installation

## 4.1 Tools Required

- sharp razor knife
- chalk-line or pencil
- measuring tape
- 2" cap screws, or equal
- fastener-driving device
- hammertacker or other temporary fasteners

## 4.2 Overlap Requirements

- minimum vertical and horizontal overlap is 4"
- offset vertical joints minimum of 8"
- utilize factory-printed guide-marks for efficient installation (Fig. 2)



Figure 2

- Ⓐ **Vertical Overlap and Cutting Alignment Aid** = 4" (100 mm) grid
- Ⓑ **Tape Overlap Zone** (for aligning edge of Wigluv 60) = 1.2" (30 mm) line
- Ⓒ **Horizontal Overlap Zone** = 4" (100 mm) line
- Ⓓ **Metric Measuring Aid** = 39-3/8" (1000 mm) line



---

## 4.3 Sheet Installation Process

### 1. Orient Course

- establish level and mark substrate
- use  $\frac{3}{8}$ " T50 staples or equal to temporarily fasten upper corner at level mark

### 2. Unroll and Fasten Temporarily

- maintain level and unroll material flat and without wrinkles
- while unrolling, continue to fasten along printed overlap zone
- fasten every 24" - 36" within coverage area

### 3. Cut to Length

- use printed Cutting Alignment Aid (4" grid) to cut material squarely

### 4. Mark Location of Stud Centers

- use light-colored lumber crayon

### 5. Tape Overlaps with Wigluv 60

- avoid tension or wrinkles
- align with printed overlap lines
- press on firmly

### 6. Install Permanent Fixation

- locate stud centers based on Step 4 above
- refer to schedule in Part 4.4
- use Cutting Alignment Aid (4" grid) to visually maintain plumb



---

## 4.4 Fastening Schedules

Well-constructed air-barrier assemblies will undergo cyclic positive and negative pressurization over the life of the building, due to climate, site orientation, and other physical factors. Due to the high air-penetration resistance of Majvest in such assemblies, permanent mechanical fastening to substructure is vital to predictable, long-term performance.

The following recommendations rely on Majvest as the primary air-barrier material of the assembly. Fastening schedules and other air-leakage strategies may be modified or reduced for non-air-barrier installations.

### 4.4.1 Temporary Fixation with Staples (Fig. 3)

Maintain flatness and position of Majvest courses by fastening directly into sheathing, for temporary mounting only. Ensure wind-load requirements are met with additional permanent fixation (see 4.4.2 through 4.4.4).

- use 3/8" T50 staples or equal
- 1" plastic caps are recommended
  - > maintain minimum 2" perimeter around rough openings
  - > aid in identifying penetrations for air-barrier quality control
- fasten approximately every 12" along each overlap and around rough openings
- fasten every 24"-36" within Field of Wall
- seal overlaps and install permanent attachment measures as soon as practical

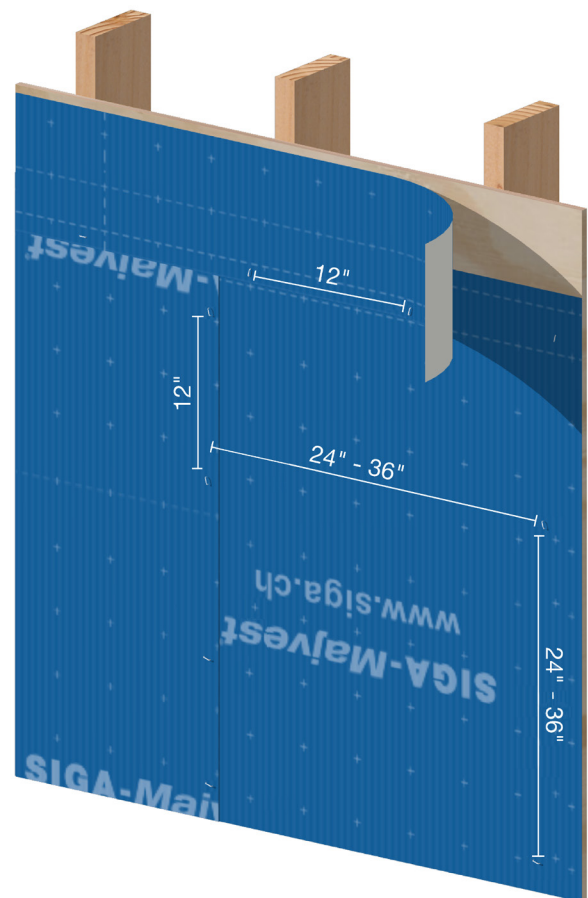

Figure 3

#### 4.4.2 Permanent Fixation Using Cladding Attachments (Fig. 4)

- align with wall studs, maximum horizontal spacing of 24"
- corrosion-resistant nail or screw fastener, sized according to shear strength and structural requirements provided by cladding manufacturer
- attachment fastener spacing maximum 24" on center vertically
- functional for permanent fixation in lieu of cap fasteners, see Part 5.3.6 for variants

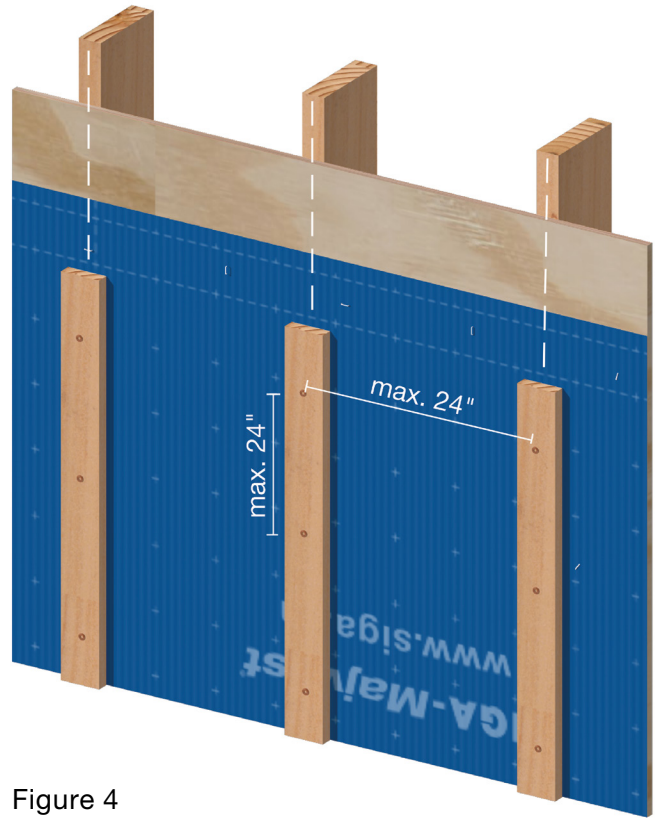

Figure 4

#### 4.4.3 Permanent Fixation to Wood Studs Using Cap Fasteners (Fig. 5)

- align with wall studs, maximum horizontal spacing of 24"
- minimum 2" long ring shank nail or wood screw with 1"-2" diameter washer
- maximum 24" spacing on center vertically

#### 4.4.4 Permanent Fixation to Steel Studs Using Cap Fasteners (not shown)

- align with wall studs, maximum horizontal spacing of 24"
- minimum 1.75" sheet metal screws with 2" diameter washers
- 16"-24" spacing on center vertically

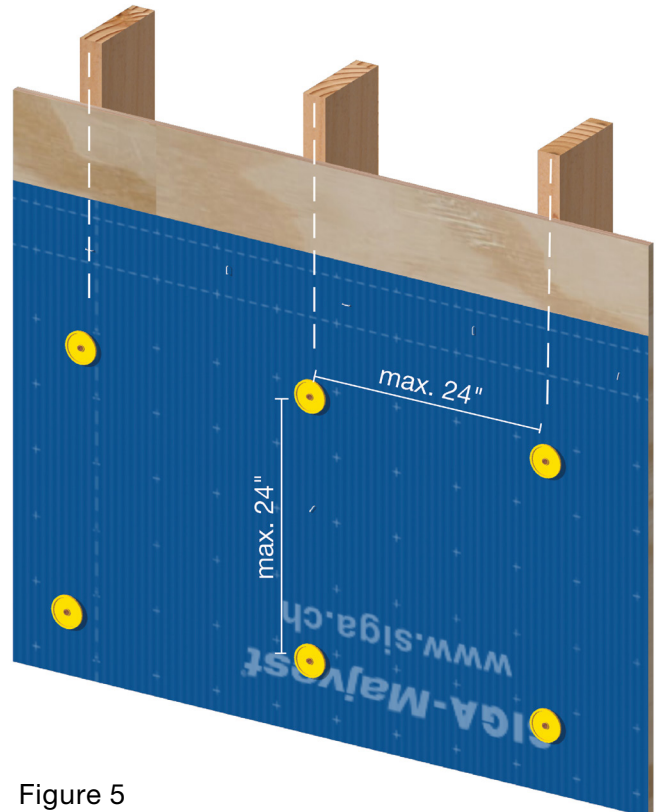

Figure 5



## 4.5 Addressing Air Leakage from Fasteners

Every penetration in the air barrier material can contribute to a cumulative decrease in system performance, if not properly addressed. Use the following optional measures to reduce the air-leakage impact of fastener penetrations through the installed Majvest membrane.

- tape over each Field of Wall fastener with Wigluv 60 or Wigluv 100 (A, Fig. 6)
- locate fasteners within the upper Sheet Overlap Zone (B, Fig. 6)
- locate fasteners under the lower Tape Overlap Zone (C, Fig. 6)
- employ physical cladding attachments (not shown)
  - > provide mechanical compression around each fastener point
  - > use Wigluv behind attachment for additional self-gasketing properties



Figure 6



## PART 5 Construction Details

### 5.1.1 Round Penetrations

1. Cut Majvest cleanly around penetration
  - recommended unsupported gap of 1/2" maximum
2. Create a gasket with short pieces of Wigluv in weatherlap fashion
  - fold tape lengthwise
  - apply to penetration, then to Majvest
  - press on firmly
3. Repeat, overlapping each piece of tape to assemble a gasket
  - always finish with the top piece

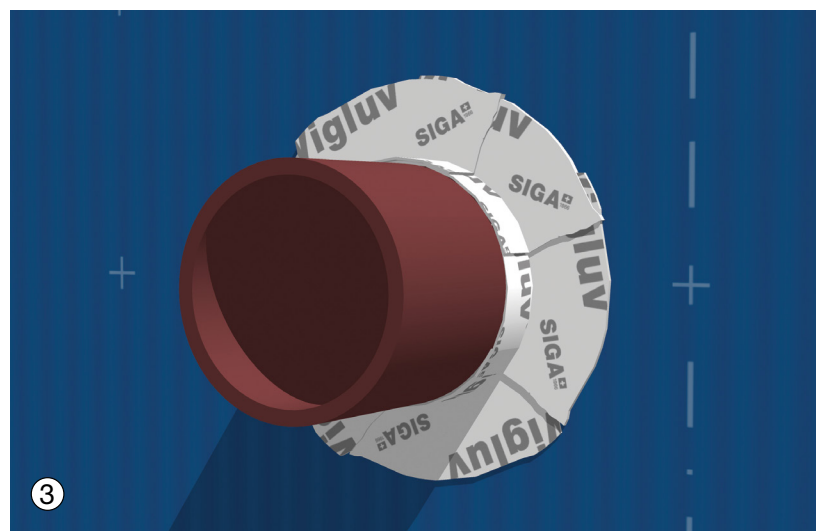
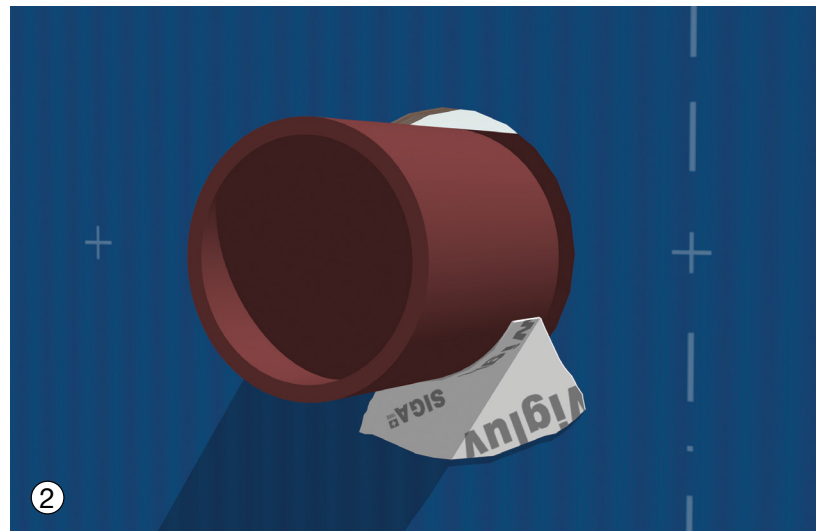
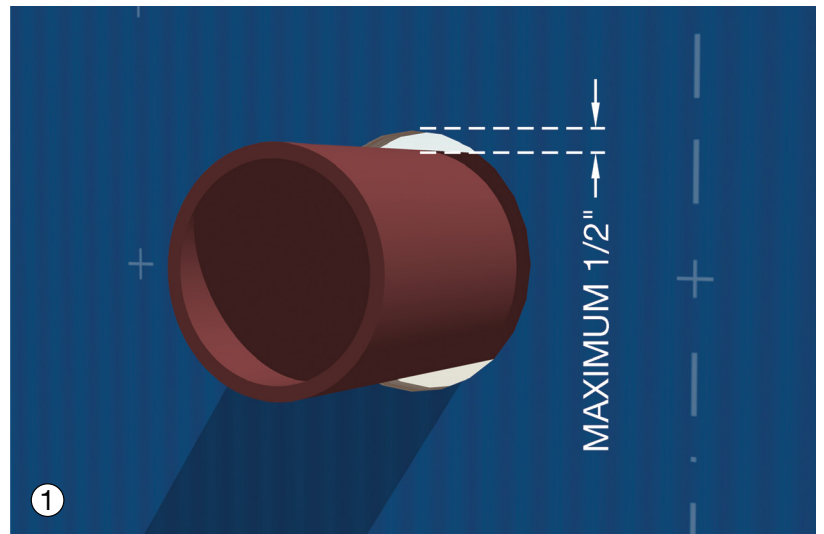

## 5.1.2 Square Penetrations

1. Begin creating the gasket, starting at the bottom

- Trim Majvest cleanly around the penetration
- Seal from bottom to top, in weatherlap fashion
  - > Cut piece of Wigluv to extend 1" past left and right horizontal edge of penetration
  - > Fold Wigluv in half lengthwise and bond to penetration, then to Majvest
  - > Make 45° cuts at each end, from the inside corner outward
  - > Press on firmly

2. Repeat for 2 vertical lengths of penetration

3. Repeat for horizontal top edge, extending minimum 1/2" wider than vertical pieces



### 5.1.3 Electrical Wires

Flexible wires and conduit present unique air-sealing challenges, due to their proximity to each other, propensity for re-adjustment during construction, and small diameter. When clustered in multiples or differing sizes, it is recommended to isolate individual wires if possible to ensure sealing in between.

1. Cut Majvest cleanly around wire.

2. Cut piece of Wigluv 100 approx 1.5" wider than each side of wire.

- Crease along split backing and remove one backing strip.
- Apply horizontally to Majvest, centered beneath wire.

3. Cut another piece of Wigluv 100 approx. 1" wider than each end of previous piece.

- Crease along split backing, remove one backing strip, and apply horizontally above wire
- Remove remaining backing strips and bond adhesive surfaces together, encapsulating the wire

4. Fold unbonded ends down at 45° and bond to underside of flap

- Integrate a weep loop into pigtail if airspace allows

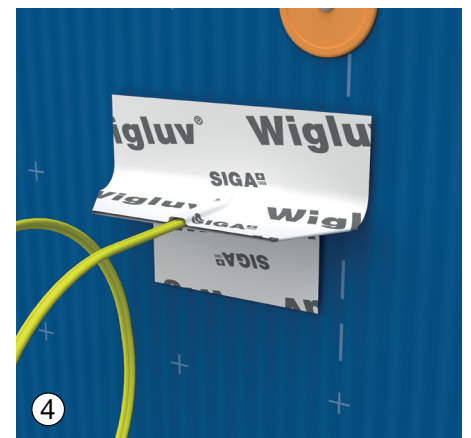
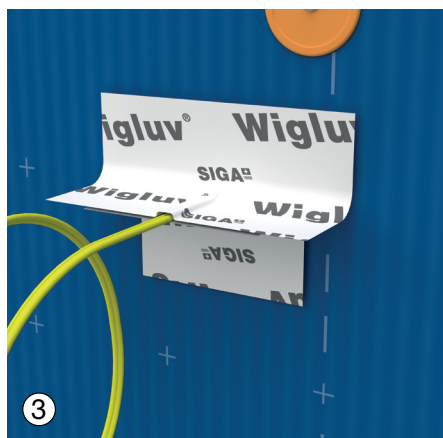
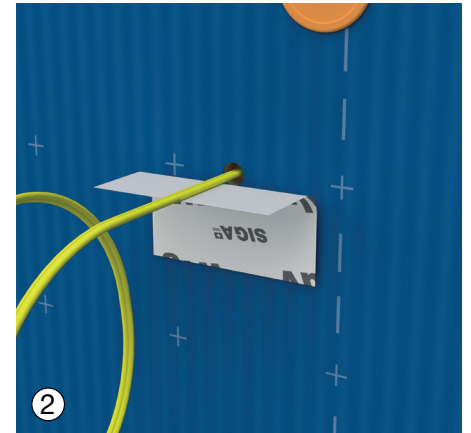
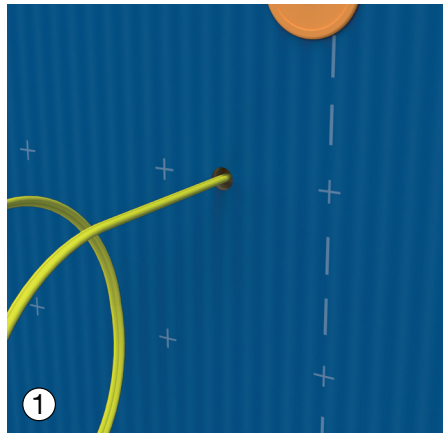

## 5.2.1 WRB Preparation: Cut-Out Method

For installations where the Field WRB will be installed before the windows (AMAA Method A), prepare the Rough Opening (RO) based on the steps below.

1. Secure Majvest around RO jamb and sill with fasteners every 12"—do not staple at the head! (low-profile T50 staples or galvanized roofing nails are recommended)
2. Cut Majvest flush with sill and jambs, and 1" above head
3. Create a flap of Majvest above RO head
  - From each upper corner, make a 9" cut upwards at 45°
  - Fold flap up and secure temporarily to avoid interference with pre-flashing
  - Proceed with pre-flashing and window installation (Section 5.2.3)

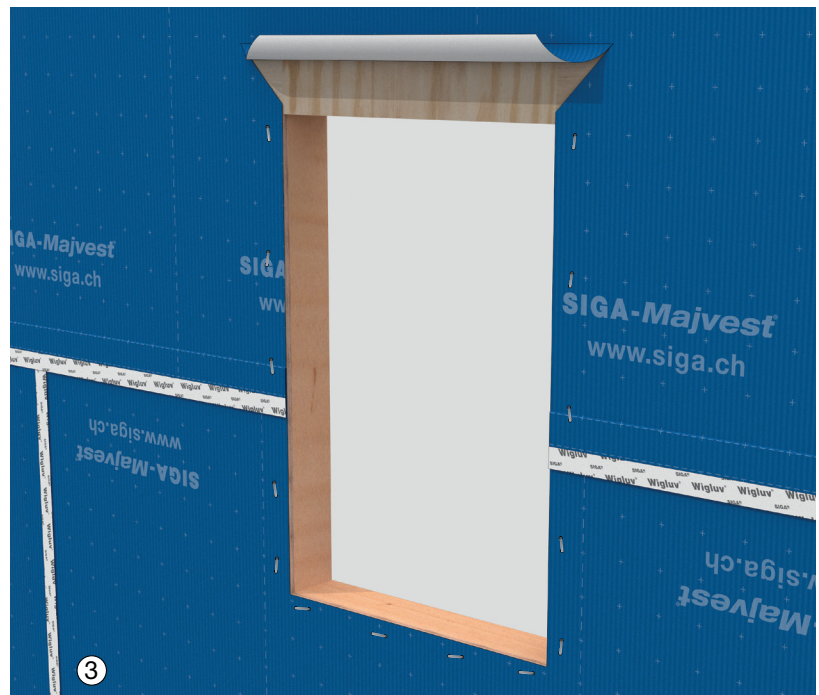
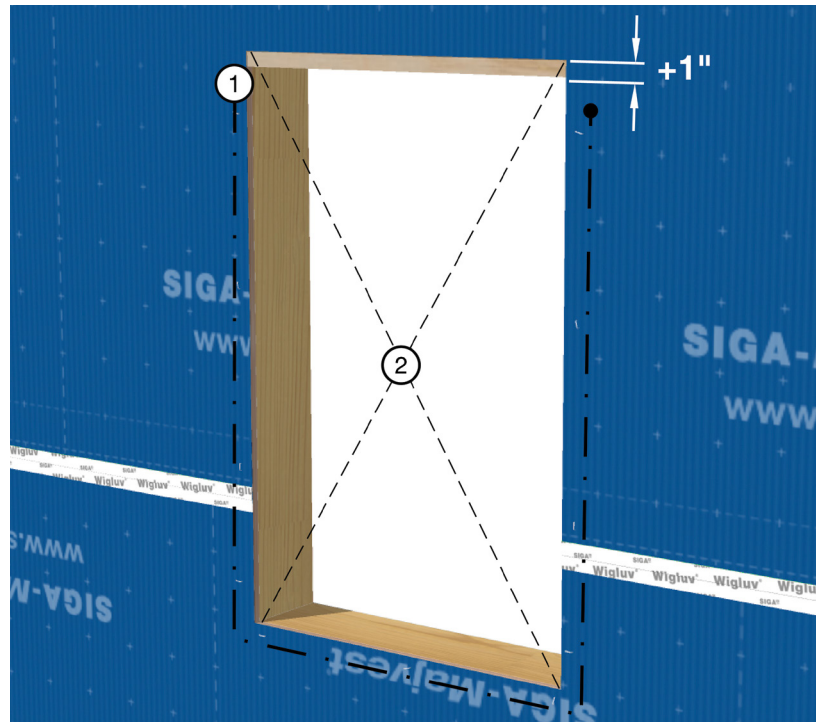



### 5.2.2 WRB Preparation: Target Method

For installations where windows will be installed before the Field WRB (AMAA Method B), install an 'apron' of Majvest before pre-flashing.

1. Install 12" wide Majvest pre-strip at face of sill
  - size strip +6" wider than each end of RO
  - fasten every 12" along top edge only, using T50 staples or nails
2. Proceed with pre-flashing and window installation (Section 5.2.3)

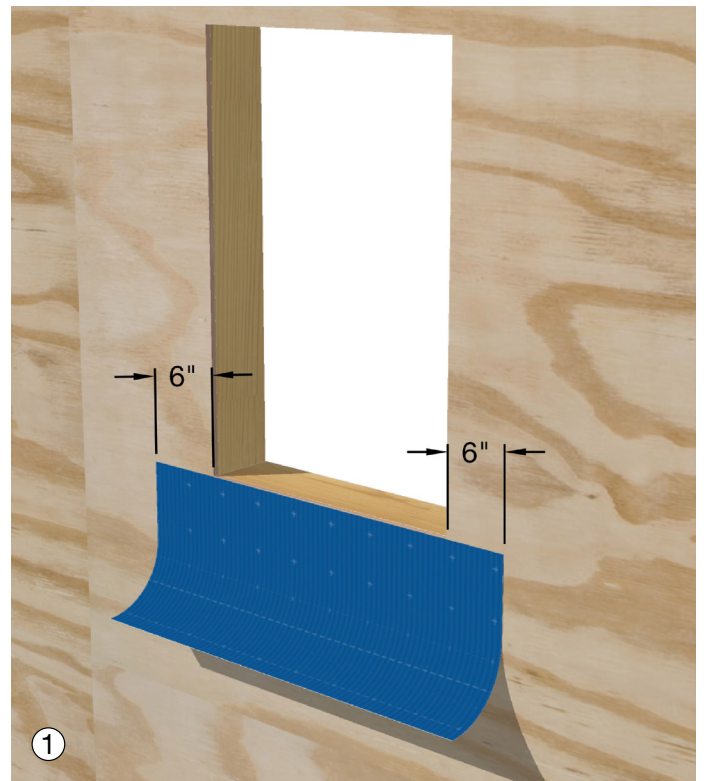

## 5.2.3 Pre-Flashing

### Sizing Requirements:

- minimum coverage 3" onto exterior
- coverage into RO  $\geq$  thickness of window
- process is the same for either WRB Integration method (Cut-Out Method shown)

### 1. Flash Sill

- cut to length: full width of sill + 4", to extend 2" past each end
- crease along split backing and remove one backing strip
- center, apply to exterior face
- cut along crease from each corner to end
- remove second backing strip and fold into RO
- work out from center, upturning excess at each end
- Press on firmly

### 2. Create Gusset with Wigluv 100

- cut to length: full depth of RO + 3"
- crease along split backing
- trim off 45° angle "dog-ear"

### 3. Sill Gussets

- install crease into lower corners of RO
- fold surplus onto exterior at a 45° angle
- spread from center to reduce wrinkling
- press on firmly

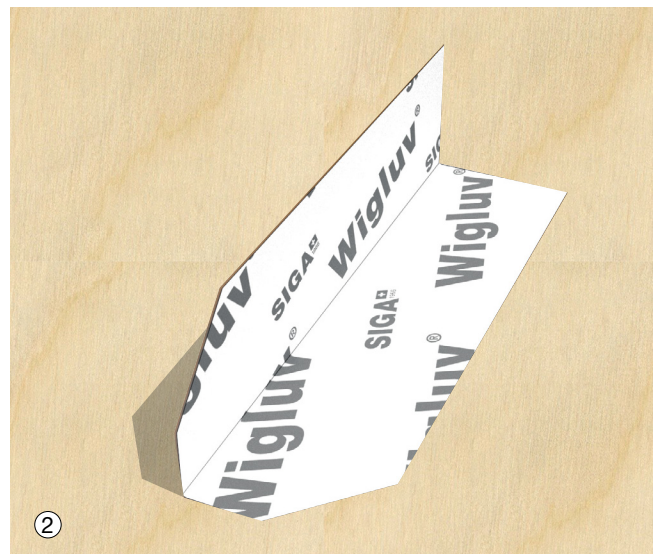
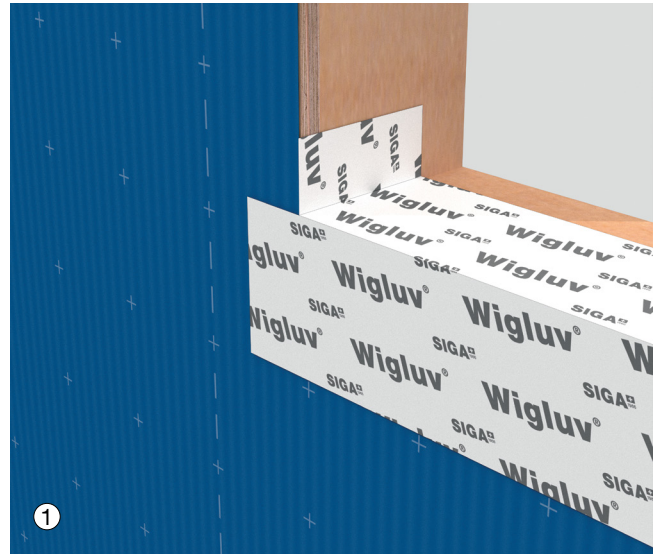

## 4. Flash Jamb

- cut to length: top of jamb +2" and flush to bottom edge of Wigluv sill flashing
- repeat sill flashing method

## 5. Head Gussets

- Repeat Steps 2 & 3 at upper corners of RO

## 6. Flash Head

- cut to length: minimum 1" wider than outer edges of jamb flashings
- repeat sill flashing method

7. Proceed with Window Installation, per manufacturer's recommendations

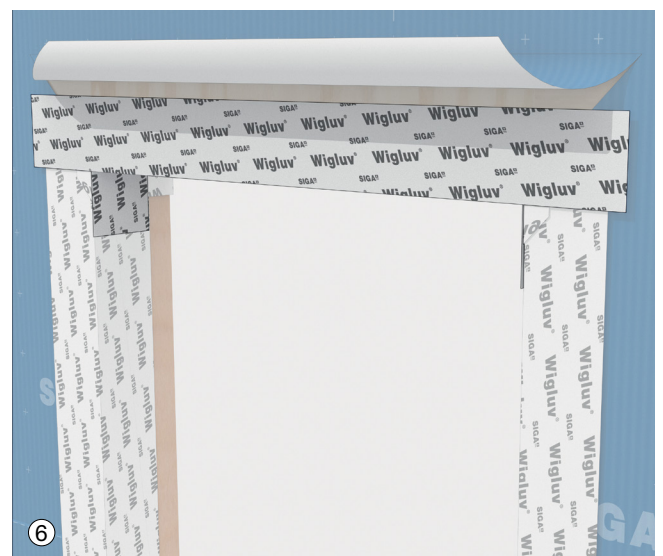
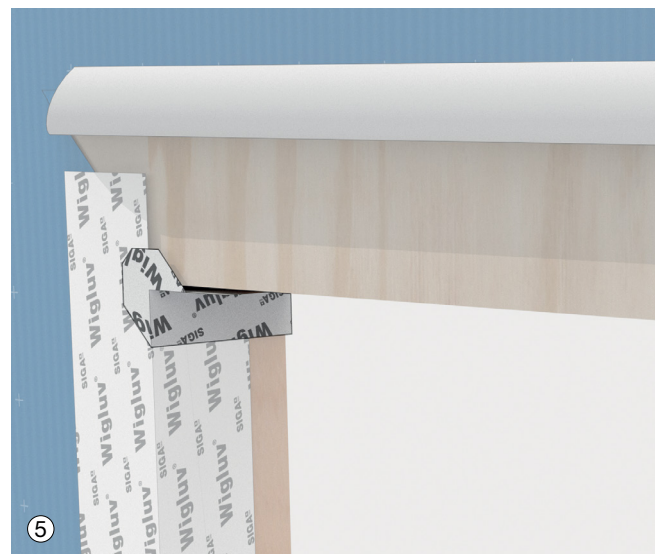
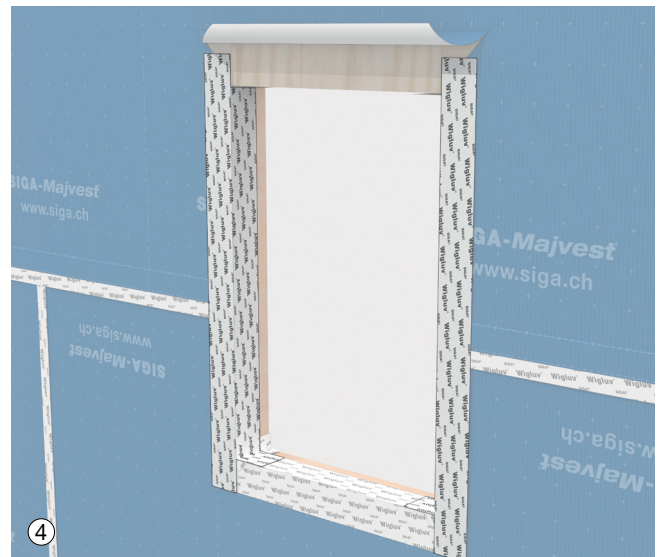



## 5.2.4 Back-dam Waterproofing at Sill

Sill drainage strategy will enhance the long-term durability of window installations, and may be mandated in certain jurisdictions. A rigid back-dam with flat sill and Wigluv-formed pan is illustrated here. For additional options, consult your local SIGA representative. Install Back-dam procedure in conjunction with Pre-Flashing sequence.

1. Fix back-dam material to sill per project specification (plywood shown)
2. Install Majvest according to either Cut-Out method or Target method (shown)
3. Flash Sill with Wigluv
  - cut to length: full width of sill +4", to extend 2" past each end
  - crease along split backing and remove one backing strip
  - center, apply to exterior face
  - cut off 2" extension from each end of unadhered flap
  - remove second backing strip and fold into RO
  - fold into crease and over top edge of backdam

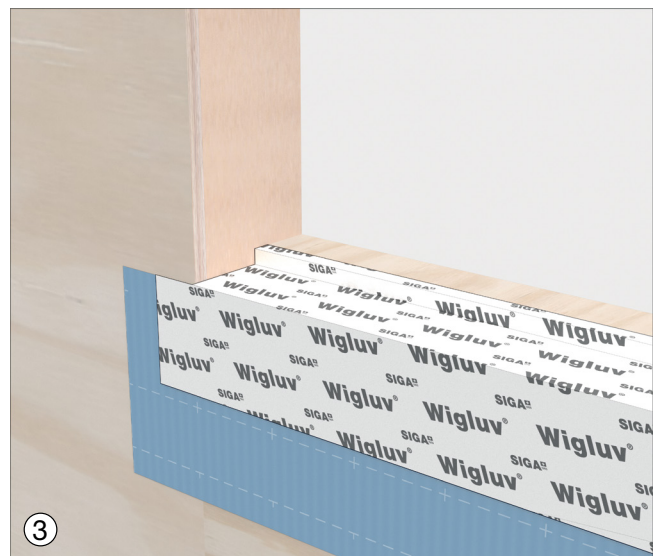
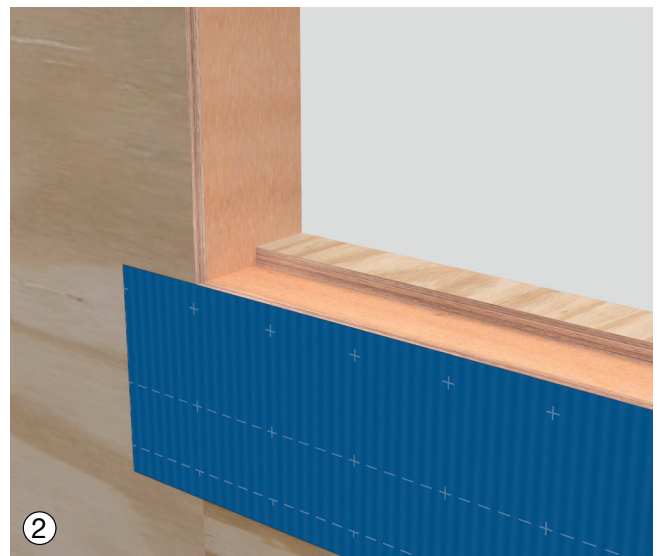



4. Install Sill Gussets with Wigluv 100
  - cut to length: back-dam depth + 3"
  - install into lower corners of RO
  - fold surplus down at a 45° angle onto the exterior
5. Install 3D corner boot (see 5.2.5)
6. Flash Jamb
  - RO return dimension = back-dam depth
  - ensure handle from boot is sealed underneath
  - maintain 3" minimum width coverage on exterior
7. Continue with remaining Pre-Flashing Steps (see 5.2.3)

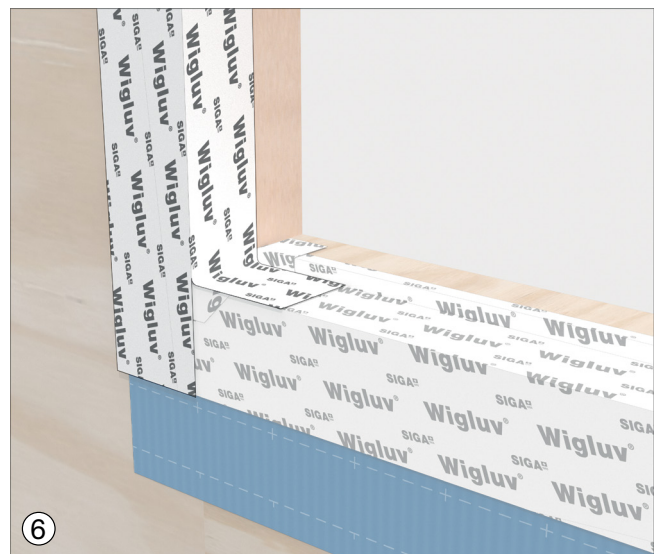
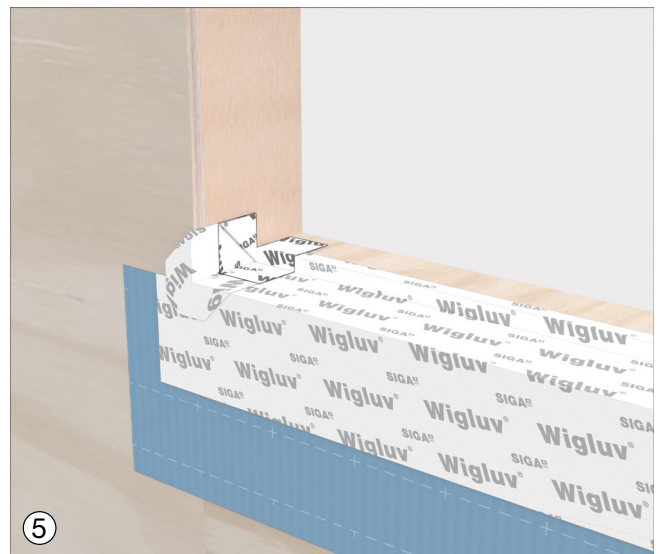
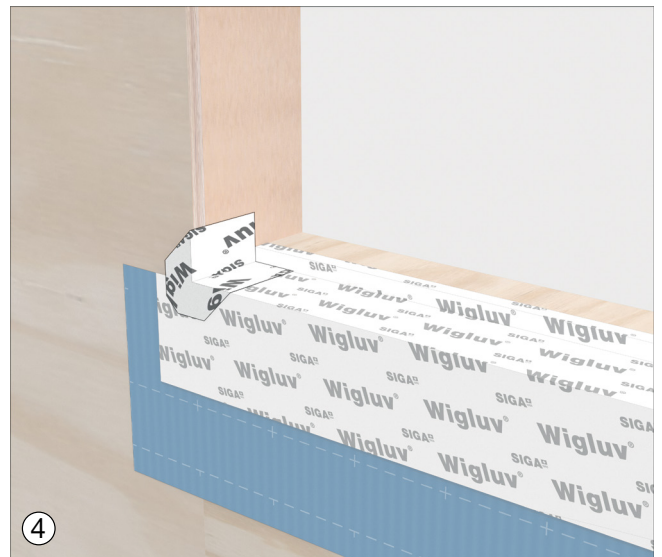

## 5.2.5 Sill Pan Boot Creation

Use Wigluv 100 to construct a 3-dimensional, watertight inside corner.

1. Cut 4" piece of Wigluv 100 and crease along split backing
2. Remove 2" of backing material and crease
3. Fold exposed adhesive at 45° onto itself, so that the tape crease meets the backing crease
4. Press firmly
5. Unfurl the object and establish boot shape
  - position into corner using triangle handle
  - remove backing strips and bond
6. Trim top of boot to end-dam height and fold excess Wigluv onto or over back-dam
  - proceed with 5.2.3 Step 5
  - ensure triangle handle is covered by jamb flashing

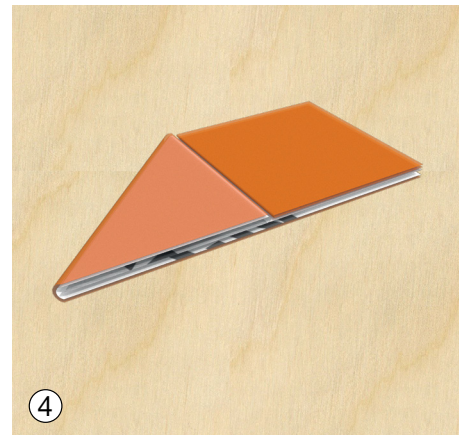
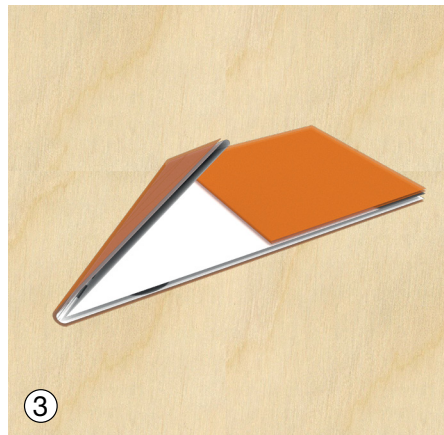
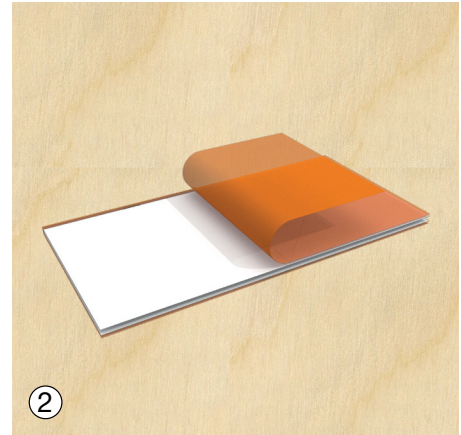
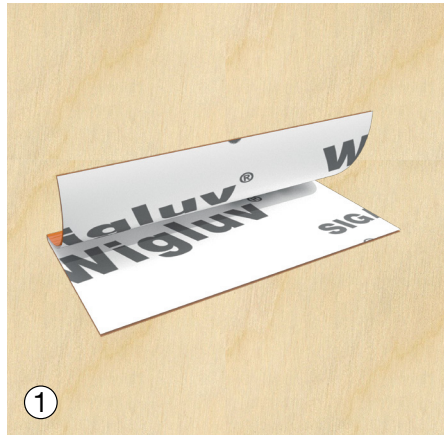





## 5.2.7 Window Installation – Non-Flanged

Use split-backed Wigluv 20/40 as shown to create a water-shedding baffle or perimeter airtight seal if allowable by code.

Install window according to manufacturer's instructions. Shim to maintain consistent 1/2" gap around entire perimeter.

1. Seal window jamb profiles
  - install Wigluv 20/40 along full length of jamb profile and extending +1" past top edge
  - do NOT cover joint at sill to allow for drainage, unless specified by manufacturer and allowable by code
  - Make 45° relief cut from each upper corner. Bond triangle flap to window.
2. Seal window head profile
  - install Wigluv 20/40 along full length of head profile and extending +1" past each edge of jamb tape
  - repeat 45° relief cut from each upper corner. Bond triangle flap to window
3. How it should look

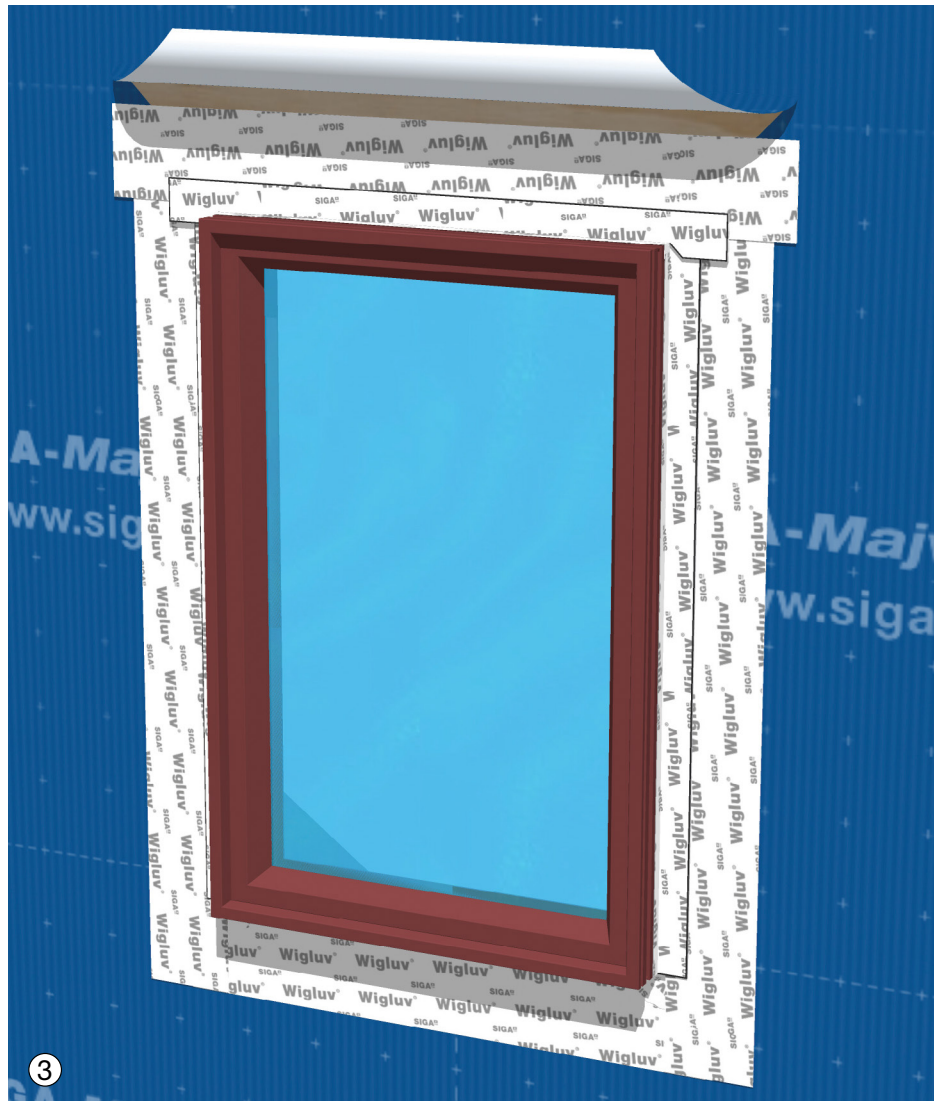
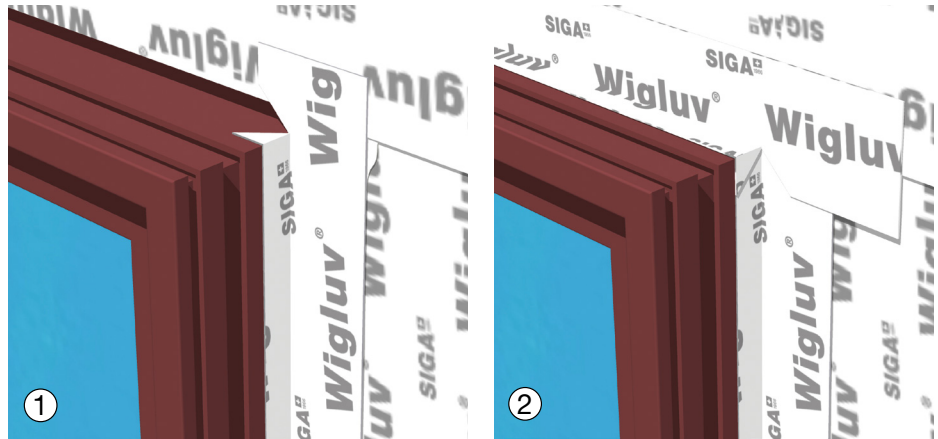

### 5.2.8 Post-Window WRB Integration: Cut-Out Method

1. Install and seal metal head flashing
  - secure mechanically to substrate
  - seal leading edge of vertical metal to substrate with Wigluv
  
2. Secure Majvest flap at head
  - lay flat on top of metal flashing
  - seal horizontal edge with Wigluv
  - seal 45° cuts with Wigluv

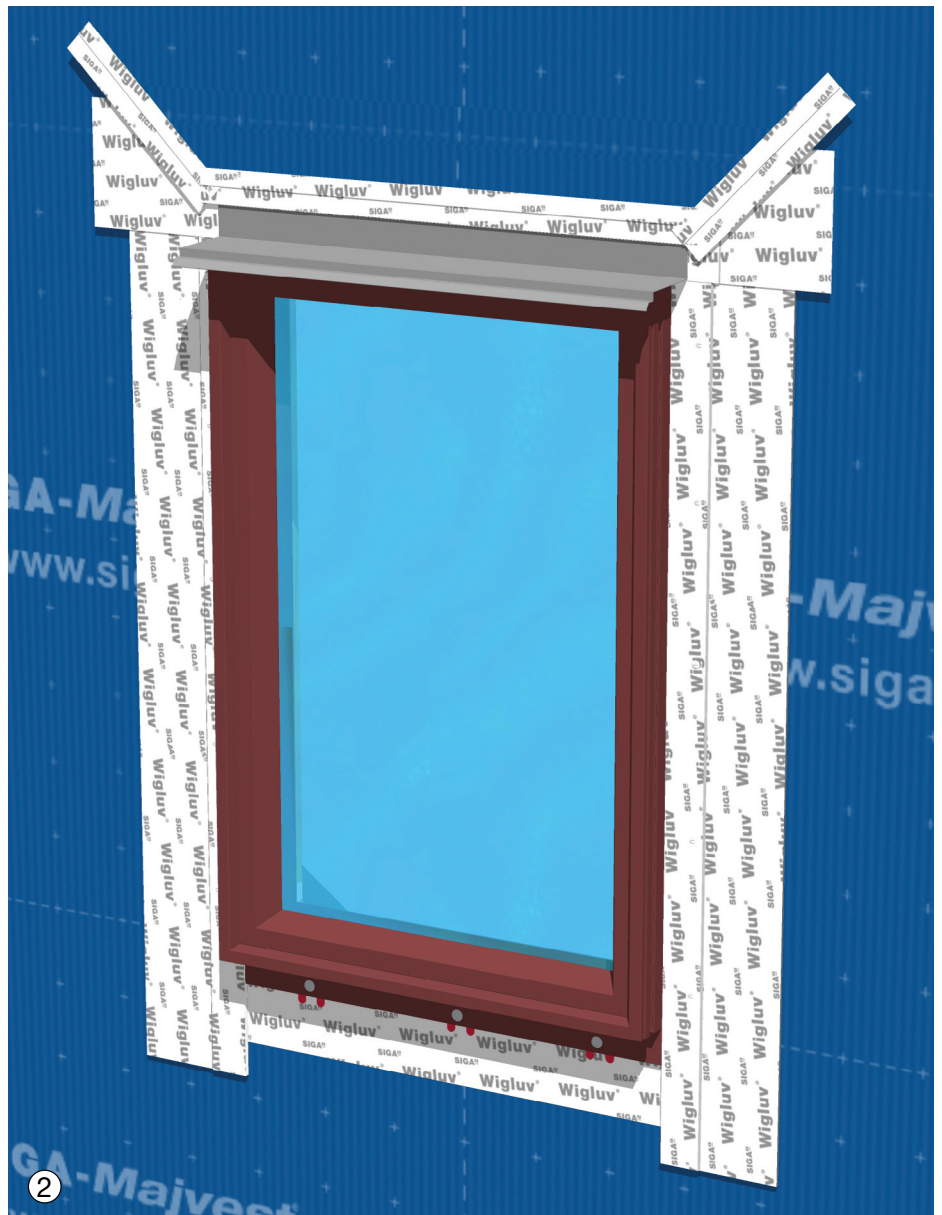
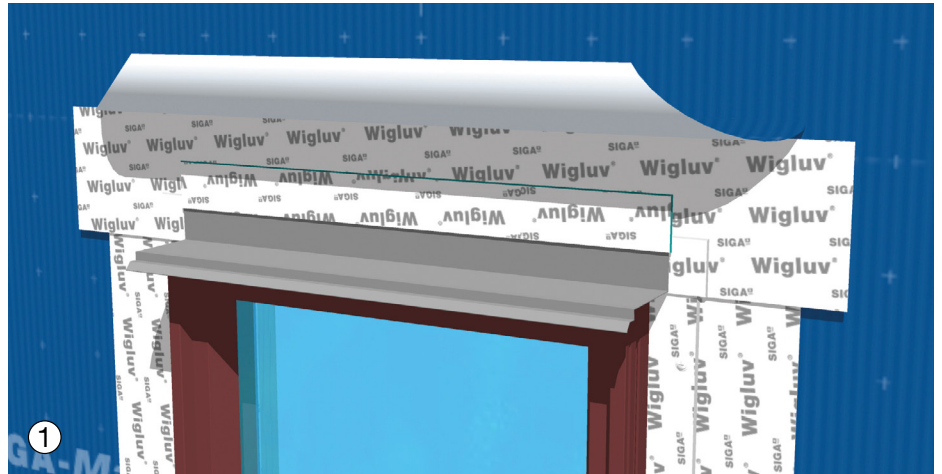



## 5.2.9 Post-Window WRB Integration: Target Method

1. Install and seal metal head flashing
  - secure mechanically to substrate
  - seal leading edge of vertical metal
  - to substrate with Wigluv.
2. Install Majvest Field WRB, maintaining 4" overlap requirements
  - integrate lower course under Majvest "apron" below window.
  - provide 1" offset of Majvest at jambs and head, to allow for sealing cut edges
3. Seal all overlaps with Wigluv 60



### 5.2.10 Interior Air-seal

Due to the necessity for bulk water drainage at the sill, the Air Barrier must transfer to the interior of the window component for a continuous seal. Alternate solutions are available depending on detailing of installation clips, finish trim or drywall reveal, cure time, and overall constructability. Consult a SIGA representative for project-specific guidance. Before proceeding, windows should be installed and insulated per manufacturer's instructions, with exterior flashing applied.

1. Ensure joint design will make continuous contact with a fully air-sealed RO.
  - seal or fill any knockouts, knots or other holes in RO framing
  - entire depth of RO should be sealed at sill and all four corners (exception for Back-dam)
2. Seal straight lengths
  - bond first to window, then bridge to rough opening
  - maintain consistent 5/8" contact with window frame
  - repeat for jamb, sill, head
  - press on firmly
3. Prepare corner boot
  - cut a 3" length of Fentrim® IS 20
  - crosscut at the midpoint of the narrow, 5/8" pre-folded section
  - crease the center of the uncut section and bond the two crosscut parts together, forming a boot
4. Seal all four corners
  - bond corner boot to window profile
  - remove backing strip
  - bond to rough opening.
  - repeat at each corner.

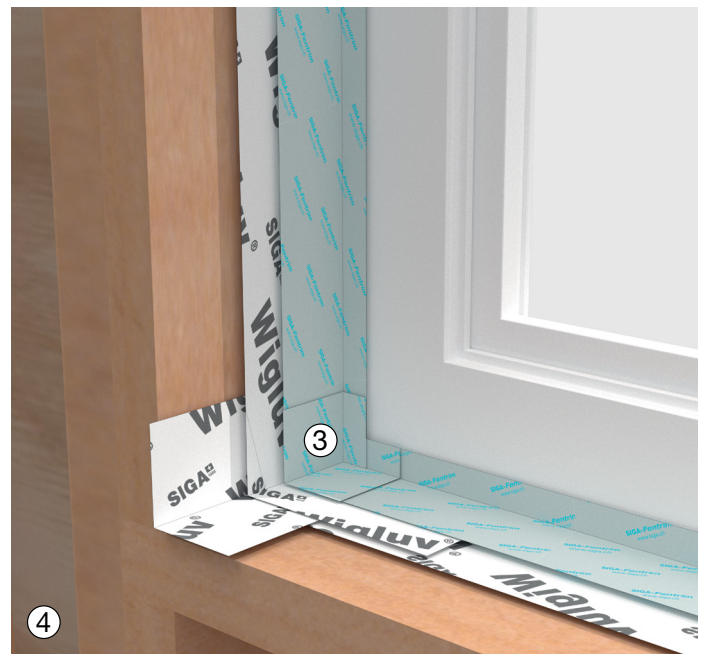
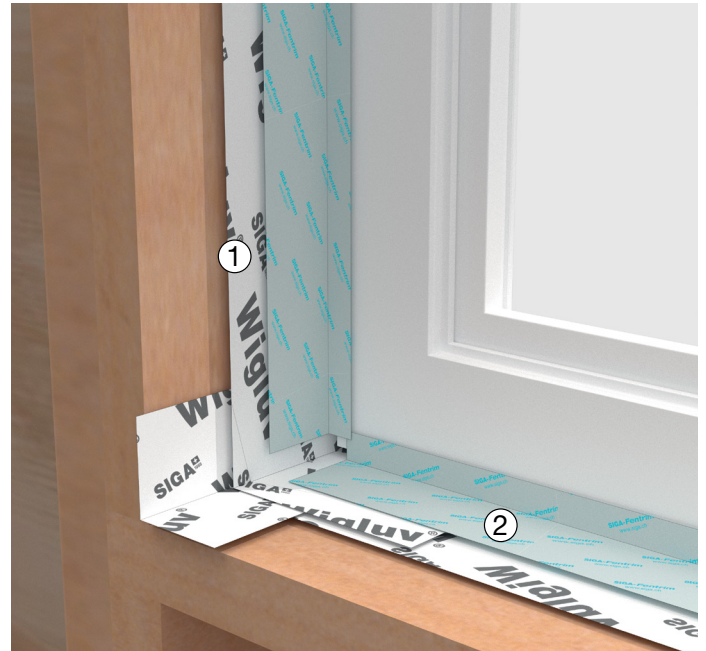

### 5.3.1 Cross-Cavity Flashing

Properly integrate metal flashings into the drainage plane, where there is a cladding transition or structural substrate transition.

1. Align lower course of Majvest approximately 3" above top of vertical edge of metal flashing
2. Install pre-primed sheet metal cross-cavity flashing with end dams, closures, and 1/2" hemmed drip edge
3. Seal sheet metal flashing to lower course of Majvest using Wigluv 60
4. Install upper field of Majvest, overlapping sheet metal flashing
5. Seal upper field of Majvest to sheet metal flashing using Wigluv 60

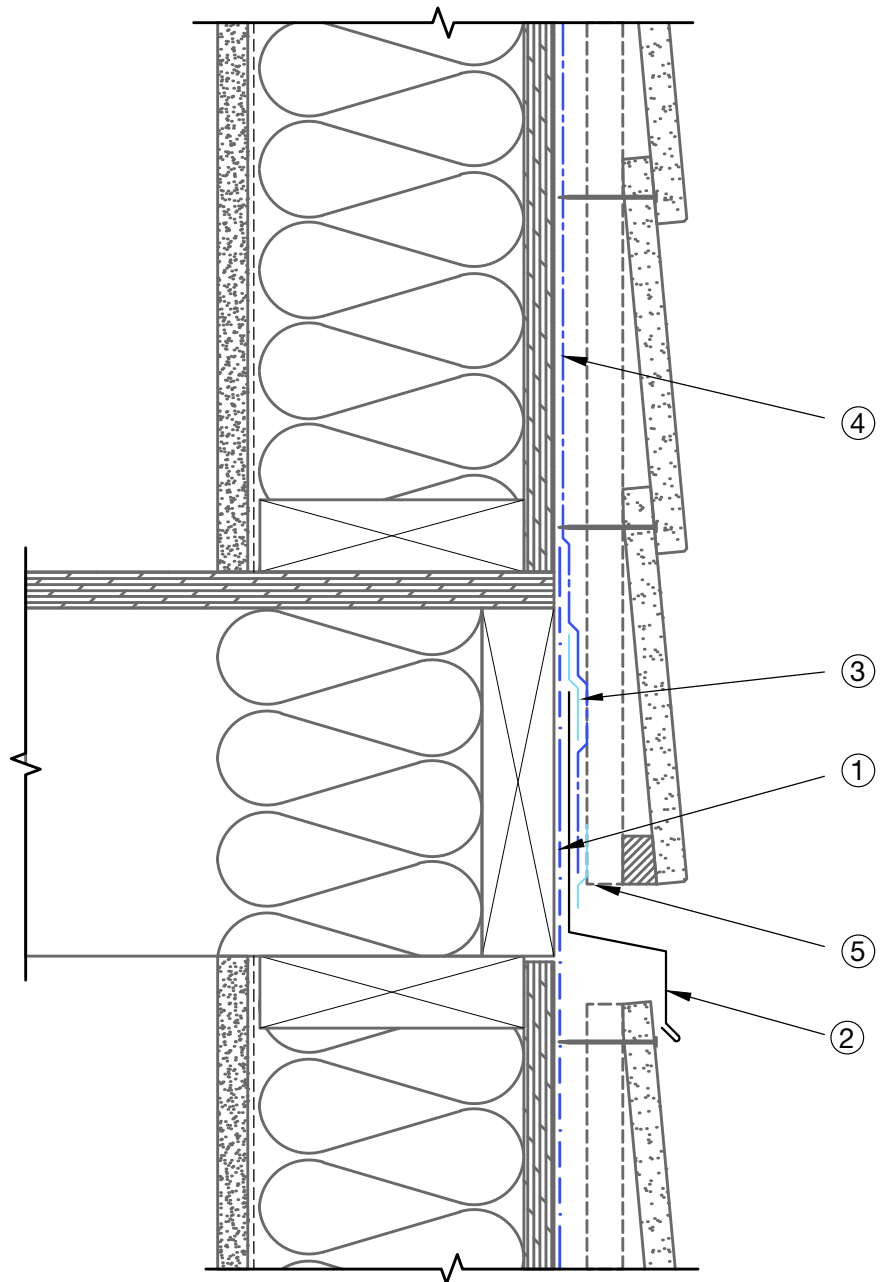



## 5.3.2 Base of Wall at Grade

Air leakage is critical to address between the sill plate and masonry foundation. Permanently seal this connection with Wigluv 230 and conclude the base of the drainage plane with metal flashing.

**1.** Clean concrete substrate and apply even coverage of Dockskin primer to upper 2" of foundation wall

**2.** Install Wigluv 230 onto sheathing and minimum 2" onto foundation

**3.** Install stainless steel metal base of wall flashing with ½" hemmed drip edge

**4.** Seal sheet metal flashing to Wigluv 230 using Wigluv 60 or wider

**5.** Install upper field of Majvest, overlapping sheet metal flashing

**6.** Seal upper field of Majvest to sheet metal flashing using Wigluv 60

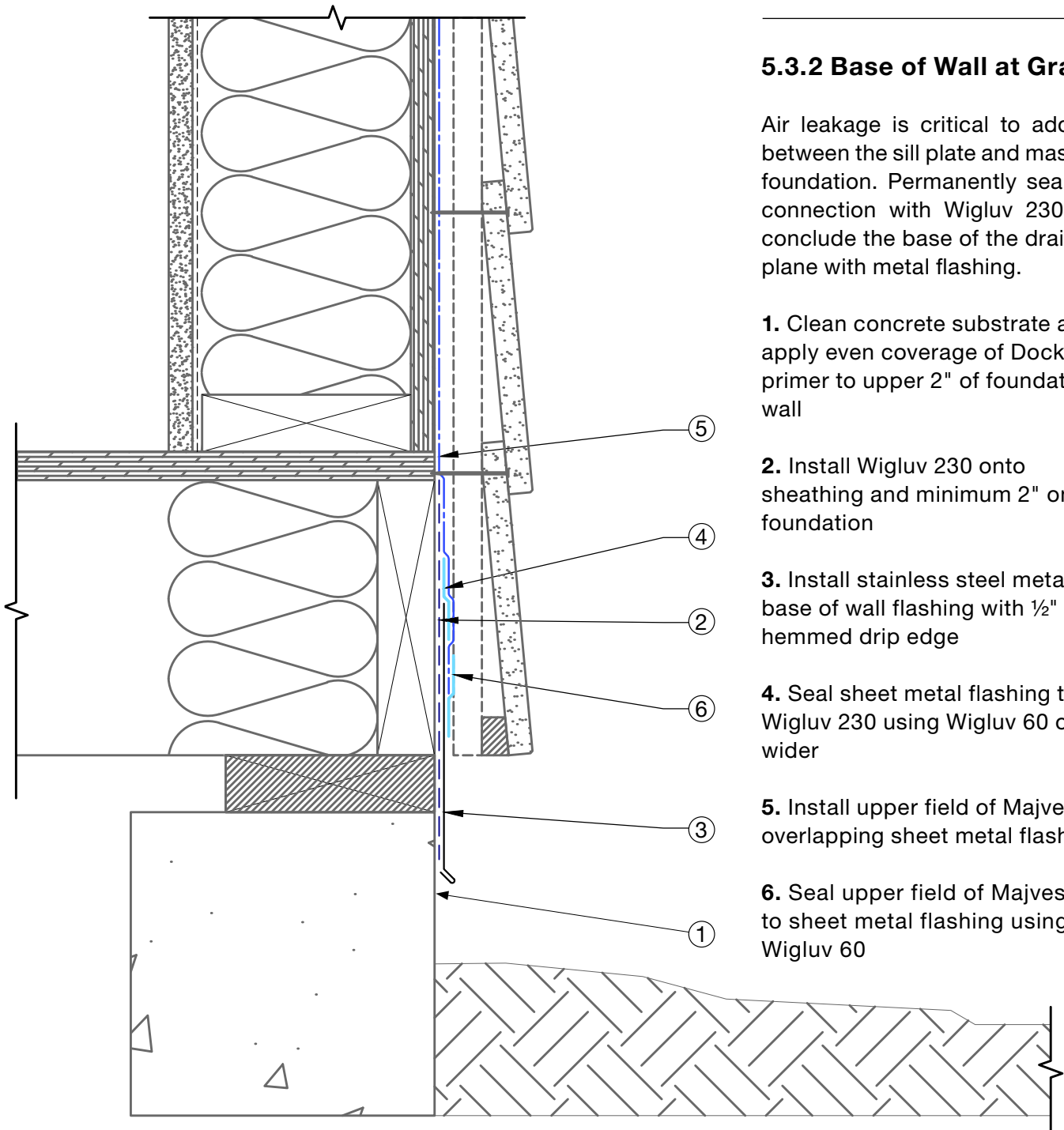

## 5.3.3 Cantilevered Floor

1. Install lower course of Majvest to align with bottom of floor framing

2. Partially install Majvest apron to sheathing of floor edge, sized a minimum of 3" above metal flashing location plus full span of soffet depth.

3. Install sheet metal flashing with 1/2" hemmed drip edge around perimeter of floor deck

*(continued below right)*

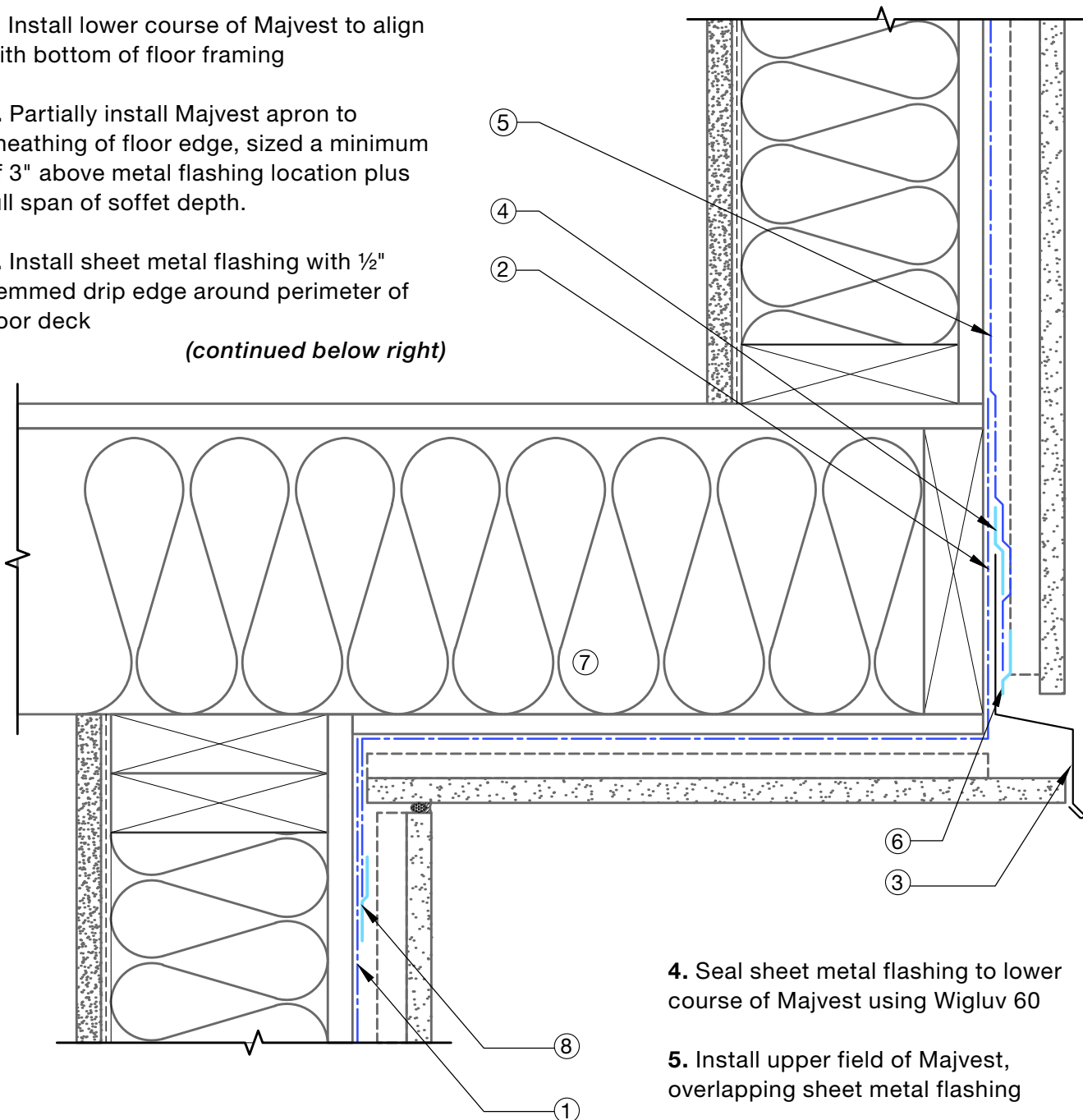

4. Seal sheet metal flashing to lower course of Majvest using Wigluv 60

5. Install upper field of Majvest, overlapping sheet metal flashing

6. Seal upper field of Majvest to sheet metal flashing using Wigluv 60

7. Insulate floor joist space

8. Secure Majvest apron across soffet and seal with Wigluv 60

### 5.3.4 Parapet at Low-Slope Roof

The unconditioned space of the parapet must be isolated from the building envelope. Maintain continuity by bridging the air barrier across the framing, for which there are numerous methods.

The method illustrated here relies on closed-cell spray foam (by others) to connect the interior air/vapor barrier (AVB) with the Majvest WRB/AB. Consult your local SIGA representative for additional options.

1. Terminate lower course of Majvest with midpoint of sprayfoam thickness, and seal to sheathing with Wigluv 60
2. Install upper course of Majvest:
  - align with top of parapet framing
  - overlap lower course of Majvest
  - seal with Wigluv 60
3. Install closed-cell spray foam into lower parapet cavity (by others)
4. Slope parapet framing to drain.
5. Install impermeable, high-temperature rated, self-adhered membrane (by others). Overlap Majvest a minimum of 4".

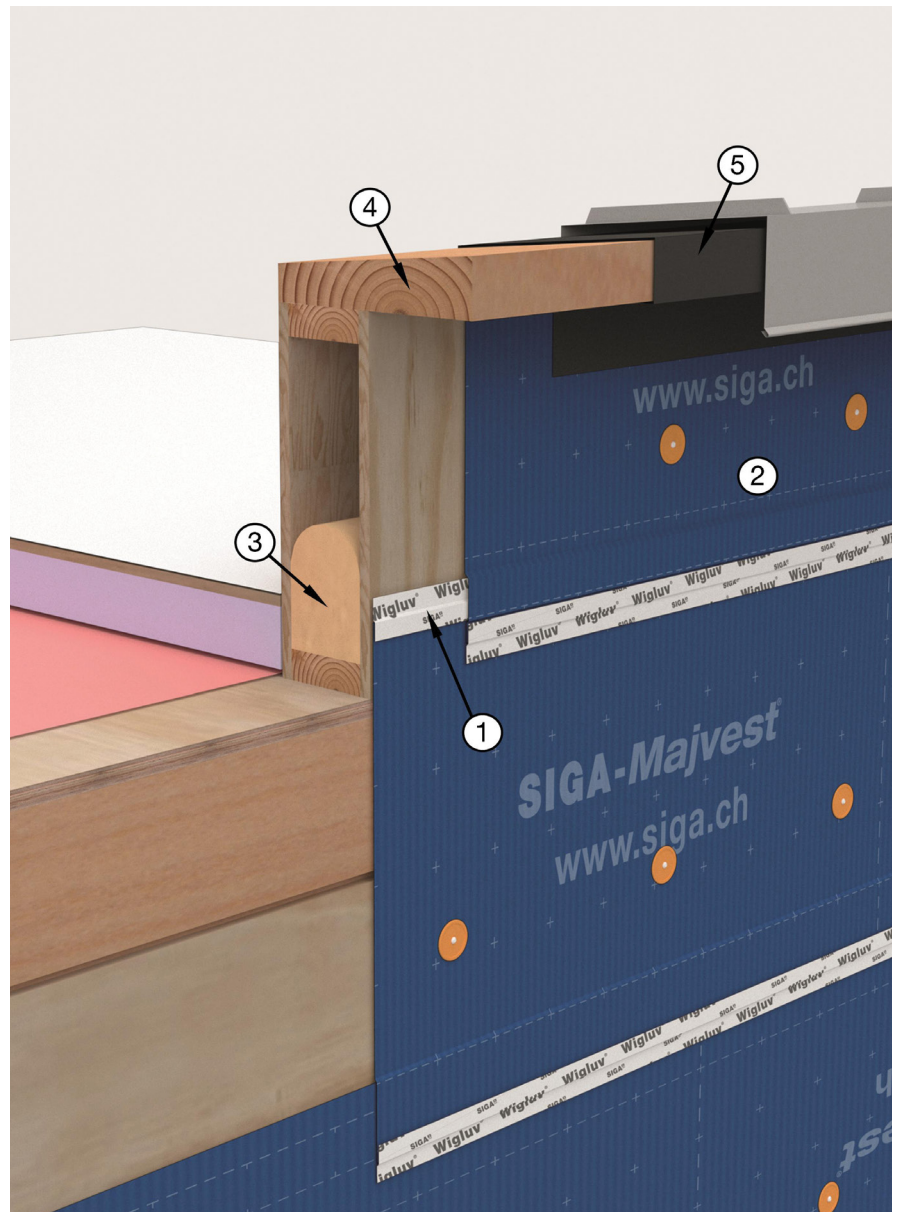

### 5.3.5 Air Barrier Transition at Eave (Vented Roof)

1. Before setting the trusses, install a narrow pre-strip of Majvest above the top plate
  - extend 4" wider than both interior and exterior of wall
  - fasten temporarily with staples
  - seal cross-wise overlaps with Wigluv

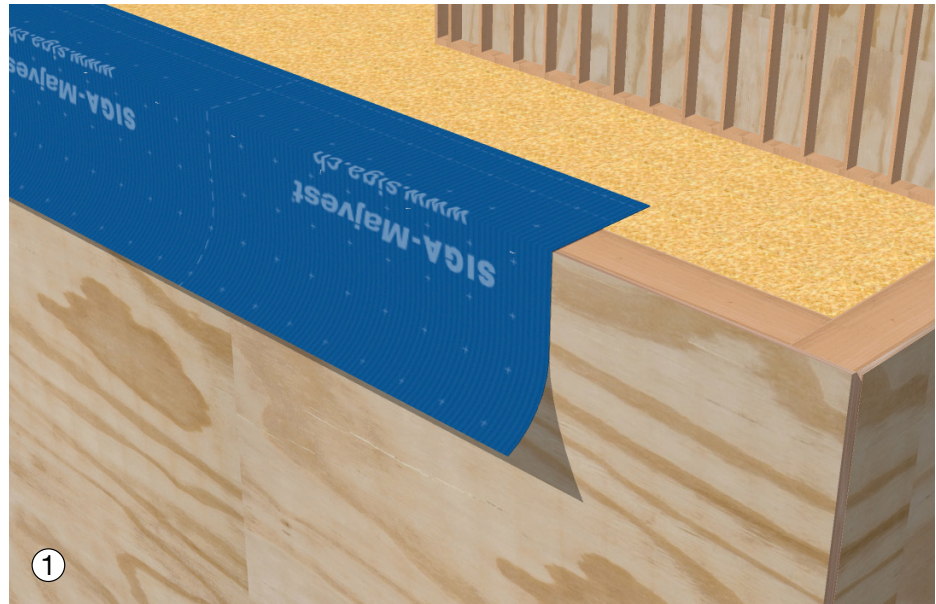

2. After roof framing has been completed, install primary Majvest Field WRB

3. Connect the pre-stripped Majvest by folding down onto the course below
  - seal all folds and overlaps with Wigluv

4. Install SIGA Majrex interior AB membrane

5. Seal interior flap of pre-stripped Majvest to Majrex using SIGA Rissan.

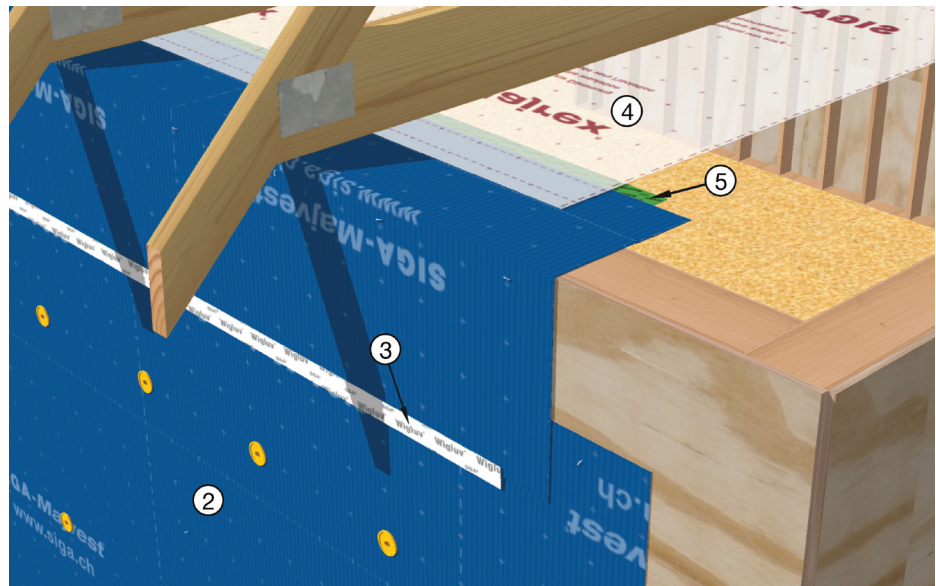



### 5.3.6 Cladding Attachments

Use Wigluv to reinforce the contact point of structural cladding attachments, such as z-girts, hat channel, and brick ties. This will increase durability of Majvest in contact with metal edges and provide self-gasketing attribute to fastener penetration points.

Required for hat-channel profiles, where penetrations are not under compression.

#### 1. Extruded, Brake-formed, or Furring Strip Attachments

- Apply Wigluv 60 or wider onto Majvest Field WRB, in alignment with structural framing members. Press on firmly
- Fasten attachment strip and directly through Wigluv-taped Majvest and into framing
- Repair any errant fastener penetrations through Majvest, per 5.3.7

#### 2. Brick Veneer Anchors

- Install Wigluv 4" or wider behind each anchor, on a 45° orientation
- Fasteners should always be embedded into structural member
- Ensure contact plate of brick tie is fully bounded within Wigluv patch area

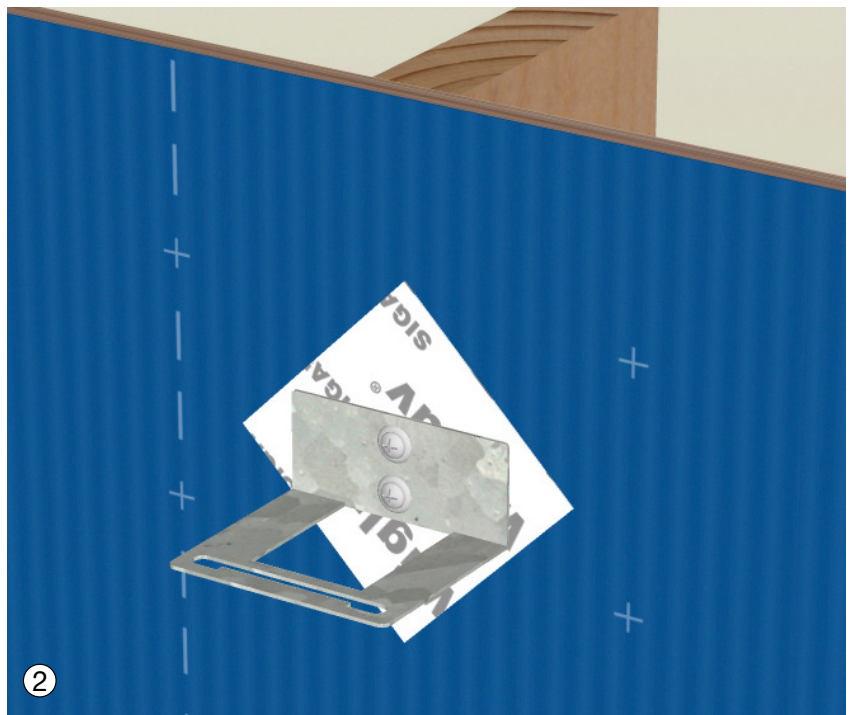
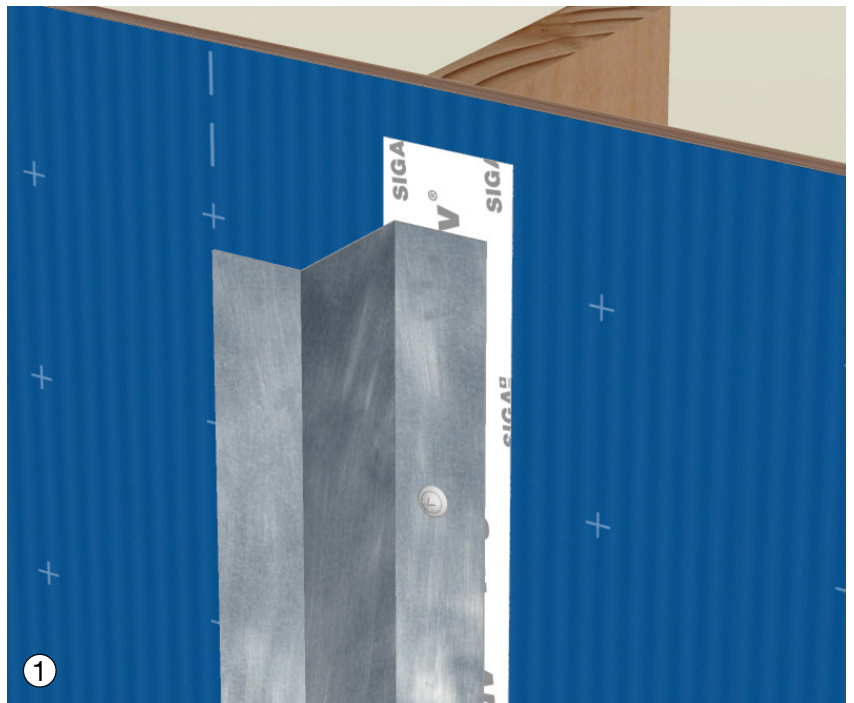

## 5.3.7 Damage Repair

### 1" or smaller

- repair using Wigluv, installed in a 'diamond' orientation
- apply to face of Majvest, centered over damage

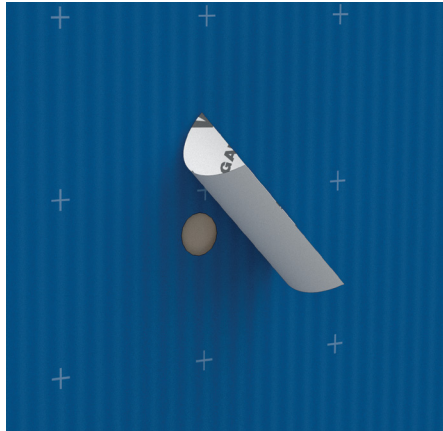

### Larger than 1"

1. Fully remove a square around damaged area
  - cut back flap of Majvest at top of area using 2 cuts at 45°
2. Apply new patch of Majvest, maintaining 4" overlap requirement
  - seal perimeter of Majvest patch with Wigluv
3. Fold flap down and seal with Wigluv

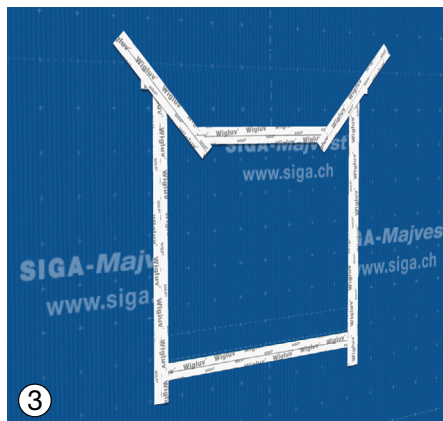

# PART 6 SIGA Reliability

---

## 6.1 Product Performance and Limitations

SIGA Cover Inc. (SIGA) products have the properties set forth in the corresponding Technical Data Sheets (available at <https://siga.swiss>). However, SIGA excludes any liability for processing or use that does not comply with these guidelines, or:

- In case of unusual influences on the product, in particular, of chemical or mechanical nature
- If permanent mechanical strain (e.g. due to tensile and compression forces) has an impact on the seal
- Multilayered sheeting or paneling materials without sufficient cohesive strength
- In case of open facade cladding with Majvest
- In the case of air-sealing in sauna and swimming pool applications
- When using Dockskin, if the primed surface is not applied with Majvest 500 SA, Wigluv, or Fentrim
- When the prerequisites for the secure laying of sheeting are not fulfilled: the substructure must be free of any protruding objects which could cause injury, such as screws etc.
- When the prerequisites for reliable sealing are not fulfilled: the substrate must be dry, structurally sound and free of any dirt, grease, and debris. It must not be adhesive-repellent. Before sealing, clean the substrate and sheeting and perform an adhesion test on site.
- If necessary, strengthen loose substrates with high-performance primer SIGA-Dockskin.
- Caution! The bonds must not be under standing water.
- Creases or tension in the sheeting or tape must be relieved by cutting and resealed.

In the IECC (2015) North America is divided into 8 different climate zones. Accordingly, different zone-related requirements are to be considered with regard to the building envelope. For information about climate zones, please refer to the International Energy Conservation Code. Consult your planner or building scientist to check whether your planned construction will meet the requirements of the respective climate zone.

## 6.2 Guidelines

These guidelines can become invalid if new knowledge is acquired or new developments are made. The current version is available at <https://siga.swiss>. SIGA assumes no liability for the accuracy, completeness or appropriateness of the drawings included in these guidelines for a specific installation or purpose. Confirm project specific conditions with a local licensed design professional in order to assure compliance with all legal requirements. SIGA is not licensed to provide professional engineering or architectural services.

## 6.3 Technical Product Properties

Adhesive: SIGA high-performance adhesives are free of solvents, VOC, high boilers, plasticisers, chlorine and formaldehyde. They cannot be removed after application.

Installation Temperature: From -10 °C / 14 °F

Service Temperature Resistance (tapes): -40 °C to +100 °C / -40 °F to 212 °F

Service Temperature Resistance (membranes): -40 °C to +80 °C / -40 °F to 176 °F

Ageing resistance: Durable adhesive power; made without rubber, resins or solvents to prevent embrittlement.

## 6.4 10-Year Limited Warranty

For complete warranty details, consult your local Application Advisor or find the SIGA Limited Warranty Document (available at <https://siga.swiss>).

Developed and produced by: SIGA©

# PART 7 Product Information

## Majvest®

Mechanically-attached vapor permeable water-resistive barrier and air barrier membrane



3-ply membrane: microporous functional layer reinforced on both sides with non-woven PP fleece Thickness: 20mils • Weight per unit area: 0.45 oz / sq ft • UV exposure: 3 months (IECC zones 3-8) • Fire behavior: Class A (ASTM E-84) • 54 US perms (ASTM E96 Method A)

- ✓ **3-layer, tear-proof and flexible**  
lays flat, installs quickly, and resists jobsite damage
- ✓ **printed cutting and overlap guides**  
save time
- ✓ **protruding roll core**  
easy to unroll without damage

### Product specifications

	Majvest 1.5 m	Majvest 3 m
ARTICLE NO.	8910-150050	8910-300050
PALLET	30 rolls	20 rolls
WIDTH	1.5 m / 59"	3 m / 118"
LENGTH	50 m / 164'	50 m / 164'
AREA / ROLL	807 sq ft	1614 sq ft
WEIGHT / ROLL	11 kg / 24.25 lb	22 kg / 48.5 lb

## Wigluv® 60

Elastic, semi-permeable tape for sealing membrane overlaps and penetrations



- ✓ **high adhesive strength at high and low temperatures**  
reliable, no building damage
- ✓ **vapor semi-permeable 1.7 US perms**  
prevents condensation build-up
- ✓ **driving rain-proof and impermeable to bulk water**  
permanent protection for roof and facade

### Product specifications

	Wigluv 60
ARTICLE NO.	7510-6040
BOX	10 rolls
WIDTH	60mm / 2.4"
LENGTH	40 m / 131'

Semi-permeable special PO film (1.7 US perms) • hand-tearable  
UV exposure: 12 months • The bond must not be under standing water



## Wigluv® 100 • 150 • 230 Low-profile, semi-permeable flashing tape for window and door installation



Semi-permeable special PO film (1.7 US perms) • UV exposure: 12 months • 1.7 US perms • The bond must not be under standing water

- ✓ **high adhesive strength at high and low temperatures**  
reliable, long-term building value
- ✓ **vapor semi-permeable 1.7 US perms**  
prevents condensation build-up
- ✓ **split backing strip**  
simple and quick to apply

### Product specifications

	Wigluv 100	Wigluv 150	Wigluv 230
ARTICLE NO.	7510-6040	7510-15025	7510-23025
BOX	6 rolls	4 rolls	2 rolls
WIDTH	100 mm / 3.9"	150 mm / 5.9"	230 mm
LENGTH	25 m / 82'	25 m / 82'	25 m / 82'

## Wigluv® 20/40

split-backed high-performance tape for sealing inside corner connections of window and door frames



Semi-permeable special PO film • UV exposure: 12 months • 1.7 US perms • The bond must not be under standing water

- ✓ **tearproof release backing with offset split**  
precise and quick in corners
- ✓ **vapor semi-permeable 1.7 US perms**  
prevents condensation build-up
- ✓ **high adhesive strength at high and low temperatures**  
reliable, long-term building value

### Product specifications

	Wigluv 20/40
ARTICLE NO.	7510-6025
BOX	10 rolls
WIDTH	60 mm / 2.4"
LENGTH	25 m / 82'

## Fentrim® IS 20

Airtight high-performance tape for window and door frames, for indoor application



semi-impermeable special PO film (0.17 US perms) • fleece-backed, formable, impermeable to water • The bond must not be under standing water  
US Patent No. 7.445.828 B2

- ✓ **high adhesive strength at high and low temperatures**  
reliable, long-term building value
- ✓ **15 mm pre-folded, without backing strip**  
fastest bonding to window frames
- ✓ **bonding from -10°C / 14°F**  
fast and tight window installation all year-round

### Product specifications

	Fentrim IS 20	Fentrim IS 20	Fentrim IS 20
ARTICLE NO.	9611-156025	9611-158525	9611-1513525
BOX	8 rolls	6 rolls	4 rolls
WIDTH	75 mm / 2.9"	100 mm / 3.9"	150 mm / 5.9"
LENGTH	25 m / 82'	25 m / 82'	25 m / 82'

## Dockskin®

High-performance primer for strengthening sandy and fibrous substrates



Water-based, solvent-free acrylate-copolymer dispersion • Shelf life: 18 months from the date of sale if unopened • Clean the brush immediately with water • Keep out of reach of children!

- ✓ **quick drying**  
saves time
- ✓ **strong penetration**  
extremely good adhesion on soft fibre boards, masonry and concrete
- ✓ **usable on cold substrates from -10° C / 14° C**  
solvent-free

### Product specifications

	Dockskin
ARTICLE NO.	5930
BOX	8 bottles
WEIGHT / BOTTLE	1 kg / 2.2 lbs
COVERAGE RATE (AREA)	5 m <sup>2</sup> / bottle 54 sq ft / bottle









# SIGA Company Values



## Tradition

For half a century and with great expertise and enthusiasm, we have been developing and producing nontoxic adhesives, tapes and membranes. In 1966, SIGA was established by Paul and Trudy Sieber-Gadient. The business was taken over by their two sons, Reto and Marco Sieber, in 1990. Since then, SIGA has prosperously evolved from a 15-man, local-rooted company to a global company with over 500 employees. In 2016, the five children of Reto and Marco Sieber decided to continue running SIGA as a family business in the third generation.



## Executive team

Today, a team of four specialists is responsible for senior management. From left to right: Peter Scherrer (CFO), Daniel Schmid (CTO), Stefan Schaab (CPO) and Patrick Haacke (CSO).

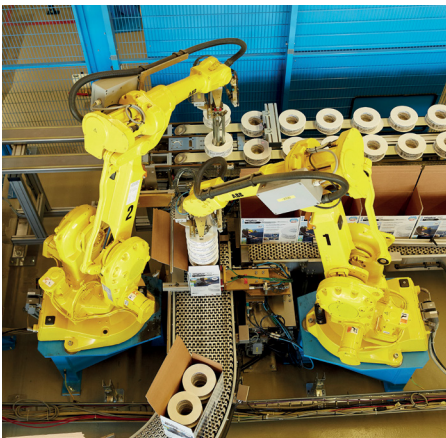

## Innovation

Each year, SIGA introduces highly innovative products and services into the market. Over the past decade, SIGA has been granted more than 30 patents in the field of adhesives, tapes, and membranes. Not only are our products highly innovative, but also is our machinery. We manufacture our products with the use of self-developed, one-of-a-kind production machines. SIGA's strive for excellence has also resulted in a unique culture of improvement. Every employee, regardless of his position, can actively optimize all aspects of our company. As a clear commitment to this culture, every 10th work day is solely used to improve the status quo and daily business is suspended.



## Passion

With highly motivated employees across 40+ countries, we aspire to meet the needs of our customers for an energy-efficient, enduring, and hazard-free building envelope. SIGA precision, combined with our expertise in roof, wall and floor connections, the installation of facades, window and door elements, pipe and cable penetrations, guarantee the highest quality and efficiency in building and remodeling.

We are very proud to actively contribute to environmental protection with our product range.



# Stick with us.

SIGA Cover Inc.  
1229 N. North Branch St.  
Suite 310  
Chicago, IL 60642  
855-773-7442

[siga.swiss](https://www.siga.swiss)

KM-10484\_SKU-2062enCA  
June 2021 Edition