

Halo® Exterra®

HALO®

ADVANCED GRAPHITE INSULATION SYSTEM

INSTALLATION GUIDE



1.0 - HANDLING, STORAGE & INSTALLATION	3
1.1 - MATERIAL HANDLING	3
1.2 - JOBSITE HANDLING AND INSTALLATION	3
2.0 – USEFUL TOOLS & MATERIALS	3
3.0 – PRODUCT DESCRIPTION	4
3.1 - FEATURES	4
3.2 - BENEFITS	4
3.3 - AVAILABLE SIZES	4
4.0 – APPLICATION	5
5.0 - INSTALLATION	5
5.1 - FASTEN EXTERRA TO THE WALL SUBSTRATE	5
5.2 - FRAMED WALLS WITH WOOD SHEATHING	6
5.3 - FRAMED WALLS WITHOUT WOOD SHEATHING	6
5.4 - CONCRETE OR MASONRY WALLS	7
5.5 - TRANSITIONS	7
5.5.1 - FOUNDATION TRANSITION	7
5.5.2 - ROOF TRANSITION	8
5.6 - SEALING JOINTS AND FASTENER PENETRATIONS	8
5.6.1 - PENETRATIONS	9
5.6.2 - OPENINGS	11
5.7 - CLADDING	13
5.8 - CAVITY WALLS	13
6.0 – FASTENING EXTERRA	14
6.1 - TYPICAL FASTENER TYPES	14
6.2 - OVER WOOD SHEATHING	14
6.3 - OVER WOOD FRAMING STUDS	14
6.4 - OVER CONCRETE OR MASONRY WALLS	15
6.5 - CAVITY WALLS	15
7.0 - INSPECTION & REPAIRS	16
8.0 - CLADDING OVER EXTERRA	17
8.1 - CLADDING OVER EXTERRA WITHOUT WOOD STRAPPING	17
8.2 - CLADDING OVER EXTERRA WITH WOOD STRAPPING	17
9.0 - AIR BARRIER	19
9.1 - ROOF/CEILING TRANSITION	19
9.2 - WALL PERIMETER AND RIM BOARDS	20
9.3 - FOUNDATION	20
9.4 - PENETRATIONS	21
9.5 - INTERIOR ELECTRICAL RECEPTACLES	21
10.0 - EXAMPLE CAD DETAILS	22
10.1 - FLANGED WINDOW INSTALLED AGAINST WOOD SHEATHING	23
10.2 - FLANGED WINDOW INSTALLED AGAINST EXTERRA	24
10.3 - ROOF TRANSITION	25
10.4 - TYPICAL WALL ASSEMBLY	26
10.5 - FLOOR TRANSITION	27
10.6 - FOUNDATION TRANSITION	28

For more information, or to contact a Halo representative, visit our website at www.BuildWithHalo.com and click “Contact Us”.

This manual will be updated regularly. Current updates will be available at www.BuildWithHalo.com.



1.0 - HANDLING, STORAGE & INSTALLATION

1.1 - MATERIAL HANDLING

Material handling, and the flow of materials from manufacturing site to job site is a significant part of the construction process. Precautionary measures taken in packaging, storage, transportation and installation of Halo products can help minimize the potential for damage to the products. Care should be taken to keep stored Halo products protected from reflective sunlight or prolonged solar exposure.

1.2 - JOBSITE HANDLING AND INSTALLATION

Precautions taken when storing insulation products on the job site can help minimize the potential for damage. Keep Halo products tarped or covered to protect from weather. Do not use a clear plastic covering film. If possible, store indoors.

Precautions taken during the construction process can help minimize the potential for thermal expansion or damage. Removing or covering the surface that is creating the reflection or shielding the affected Halo products will help restore the original dimensions in the event of thermal expansion.

For more information contact your local Halo representative or e-mail info@buildwithhalo.com.

2.0 – USEFUL TOOLS & MATERIALS

Recommended for sealing joints, penetrations, perimeter edges and flashing details

- Halo Sheathing Tape
- Perma R Products Sheathing Tape
- Vapor barrier blue or red Tuck Tape,
- 3M peel and stick membrane,
- Blueskin flashing tape and
- Expandable foam.

Recommended for fastening or gluing

- weather resistive construction glue, such as PL 300,
- plastic cap nails,
- roofing nails with at least 1/2" diameter washers,
- cap staples or
- wood screws with metal roof washers.

When fastening to metal studs use self-drilling screws with at least 1" diameter metal washers.

Additional tools:

- Hammer and cordless drill
- Utility knife and straight edge



HALO® EXTERRA® EXTERIOR RIGID INSULATION

3.0 – PRODUCT DESCRIPTION

3.1 - FEATURES

Exterra is a rigid foam sheathing insulation faced with a polypropylene laminate that is perforated to allow the sheathing to breath. The insulation is made with graphite polystyrene (GPS) which is expanded polystyrene infused with graphite particles. Insulation made with GPS provides up to 18% more R-value than conventional EPS.

Exterra products featuring a reflective laminate on one side and a clear laminate on the other should be installed with the reflective side facing to the exterior.



3.2 - BENEFITS

When installed as exterior insulation Exterra offers the following functional benefits.

- Provides continuous insulation, which reduces thermal breaks.
- Increases the R-value of wall assemblies that cannot be achieved with cavity insulation alone.
- Acts as a water-resistive barrier - eliminates the need for house wrap when the joints are sealed and taped.
This reduces air leakage and ensures moisture transmission through the cladding will drain to the outside.
A house wrap is not required with Exterra for thicknesses 9/16" or greater.
- Contains perforations, which allow Exterra to breathe.
Because Exterra is breathable, a vapor barrier may be required for the wall assembly.
Exterra remains breathable with thicknesses up to 2 inches.
- Reduces heat gains in warm climates when an air gap is provided between Exterra and the cladding.

3.3 - AVAILABLE SIZES

Available in 4ft x 8ft sheets, 1/2", 9/16", 5/8", 1", 1.5" and 2" thickness. Custom sizes and thicknesses are available. Contact your local Halo representative for availability.



4.0 – APPLICATION

Suitable for use for new construction and existing buildings, Halo Exterra is designed to completely insulate exterior above-grade walls in residential, multi-residential, commercial, and industrial buildings while providing a breathable water-resistive barrier.

In addition, the reflective surface of Exterra can reduce heat gains provided a gap over the Exterra surface is provided when installed.

5.0 - INSTALLATION

The following illustrations are typical for the installation of Halo Exterra as interior insulation.

Installation may vary depending on project specific requirements. Before starting, make sure all installation complies with local building code requirements.

Exterra consists of a perforated laminate allowing the sheathing to breath. Therefore, an additional vapor barrier may be required for the wall assembly.

5.1 - FASTEN EXTERRA TO THE WALL SUBSTRATE

Exterra is fastened directly to the wall substrate or framing members, such as wood sheathing, wood or steel stud framing, concrete or masonry walls.

Attach Exterra at corners, as a minimum, to the substrate or framing members. A minimal number of fasteners is required to tack Exterra sheets in place – the attachment of cladding, or strapping will fully secure Exterra sheets.

Place Exterra against the wall substrate either vertically or horizontally. For tall walls installing vertically is preferable.

For information on fastener information see Section 6.



5.2 - FRAMED WALLS WITH WOOD SHEATHING

Fasten Exterra directly over the wood sheathing. For existing framed wall buildings remove the cladding material and house wrap to expose the wood sheathing.

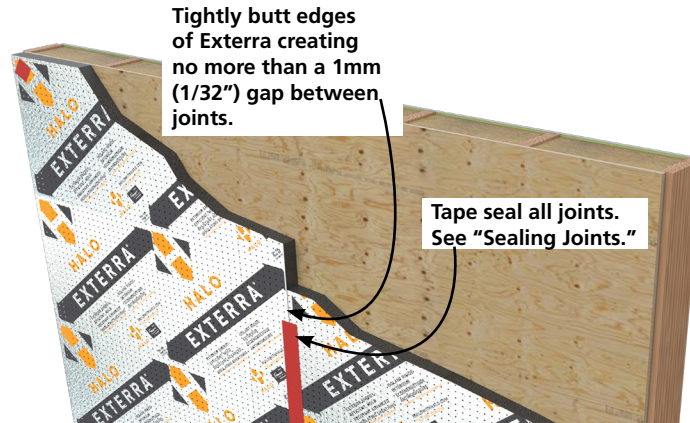

For information on fastening Exterra over wood sheathing see Section 6.

5.3 - FRAMED WALLS WITHOUT WOOD SHEATHING

Exterra can be installed directly over wall studs. Since Exterra is not structural sheathing the walls may require bracing, per local building codes.

Some examples of typical bracing include metal T-straps, or 1x4 wood let-in. Typical corner bracing includes wood sheathing at the corners, such as OSB or plywood.

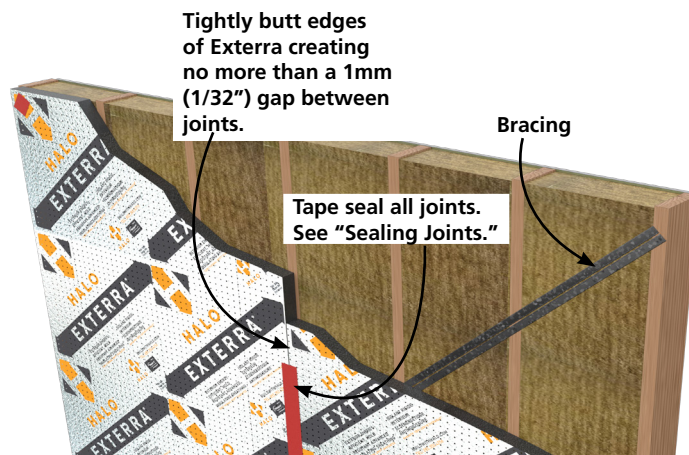

When Exterra is placed over wood sheathing used for corner bracing, furring out the remaining framing members along the wall may be necessary to ensure Exterra sheathing boards are flush with the Exterra sheathing at corners.

For information on fastening Exterra direct to wall studs see Section 6.



5.4 - CONCRETE OR MASONRY WALLS

If concrete screws are used place sheathing tape over the screws to maintain the water resistive barrier properties of Exterra

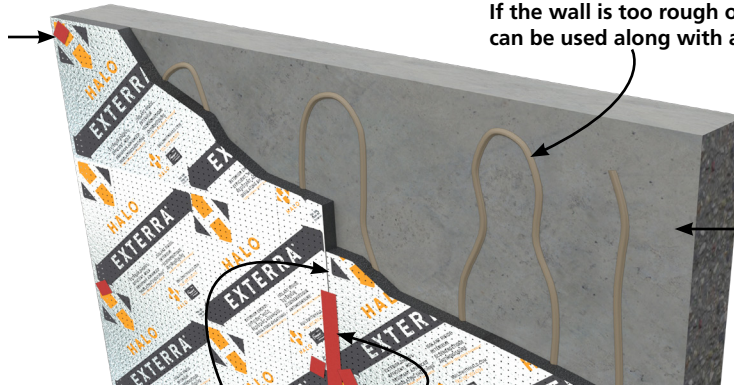

Use weather resistant construction glue compatible with EPS, such as PL 300, to secure Exterra to the wall.

If the wall is too rough or uneven concrete screws with washers can be used along with adhesives to help secure Exterra.

Remove any protrusions that can damage or prevent Exterra from laying flat against the wall.

Tightly butt edges of Exterra creating no more than a 1mm (1/32") gap between joints.

Tape seal all joints. See "Sealing Joints."

5.5 - TRANSITIONS

There are different methods to ensuring Exterra performs as a water-resistive barrier, and properly drains moisture to the exterior.

The following illustrations are detail examples for transitions the foundation and roof level.

5.5.1 - FOUNDATION TRANSITION

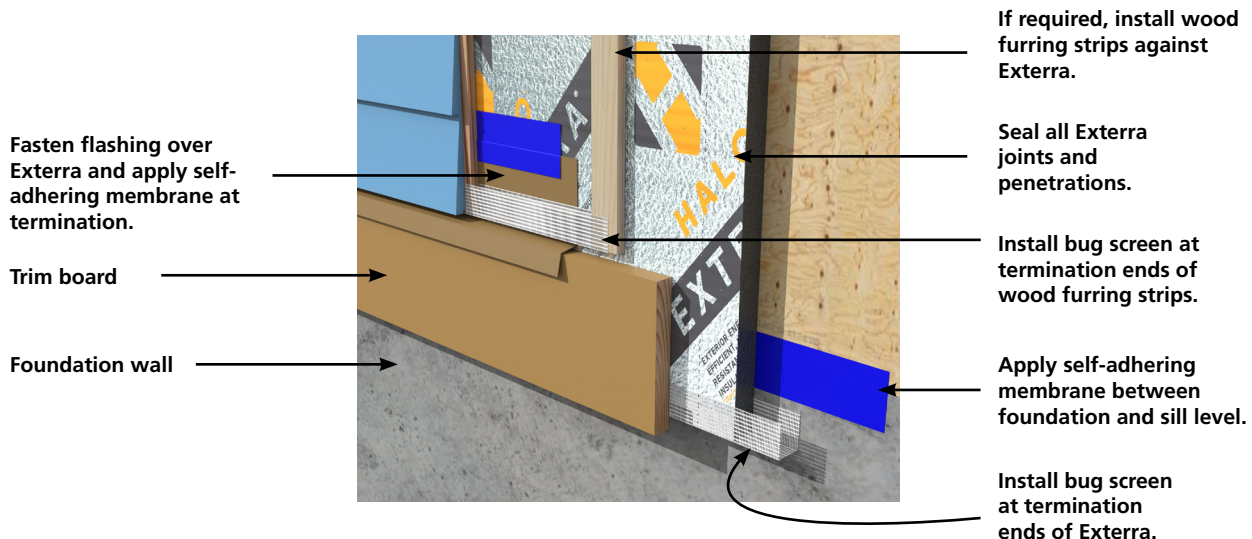

Fasten flashing over Exterra and apply self-adhering membrane at termination.

Trim board

Foundation wall

If required, install wood furring strips against Exterra.

Seal all Exterra joints and penetrations.

Install bug screen at termination ends of wood furring strips.

Apply self-adhering membrane between foundation and sill level.

Install bug screen at termination ends of Exterra.



5.5.2 - ROOF TRANSITION

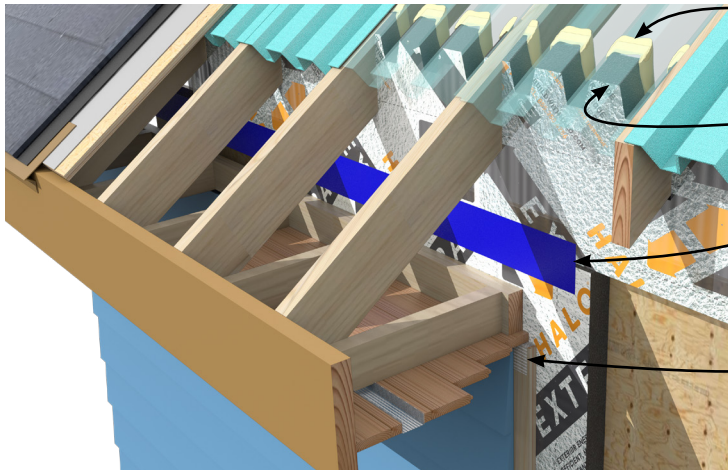

Spray foam.

Cut Exterra to underside of the roof baffles. Apply spray foam at termination.

Seal all Exterra joints and penetrations.

Install bug screen at termination ends of wood furring strips.

5.6 - SEALING JOINTS AND FASTENER PENETRATIONS

Joints between Exterra boards, and fastener penetrations, should be sealed to ensure a proper water-resistant barrier is maintained.

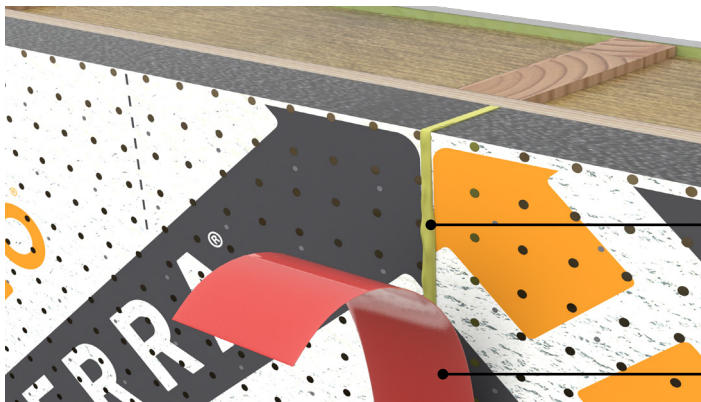

Joints should be tight and snug. Foam fill and tape over joints with gaps 1/16" or larger.

Seal all joints with sheathing or flashing tape.

Place sheathing tape over fasteners to maintain the water resistive barrier properties of Exterra

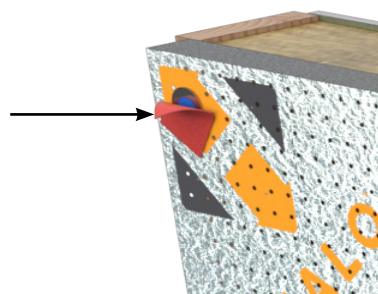

5.6.1 - PENETRATIONS

Measure and cut Exterra to suit the rough opening for penetrations. Exterra boards can be cut using a utility knife.

The following illustrations provide a typical example of addressing proper drainage and insulation around a penetration.

Step 1: Cut a rough opening.

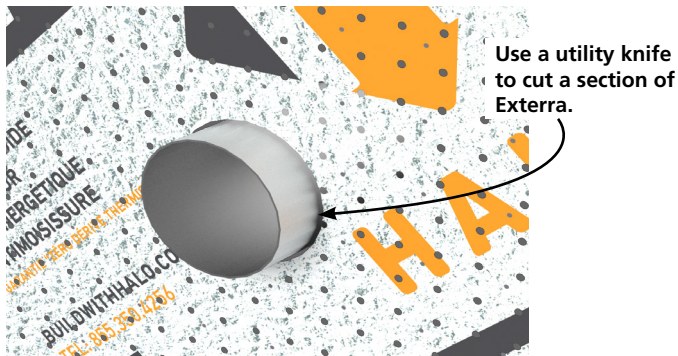

Step 2: Apply spray foam to fill gaps.

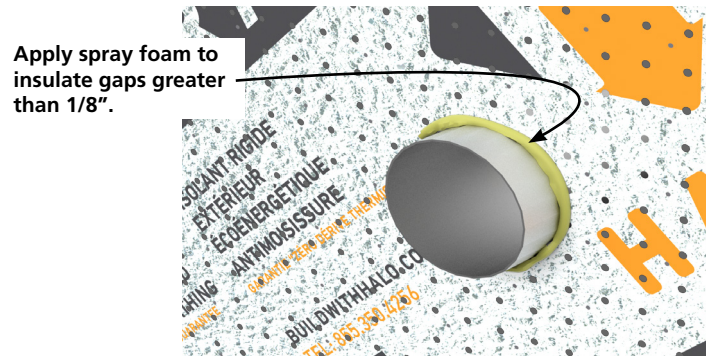

Step 3: Apply self-adhesive membrane at bottom half.

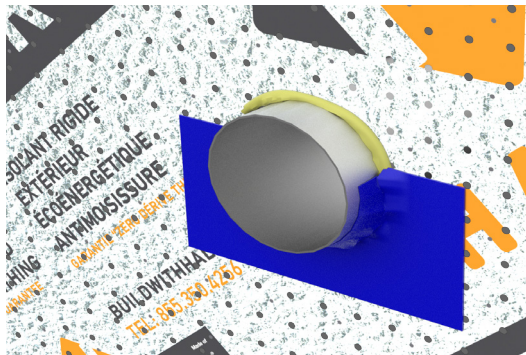

Step 4: Apply self-adhesive membrane at top half.

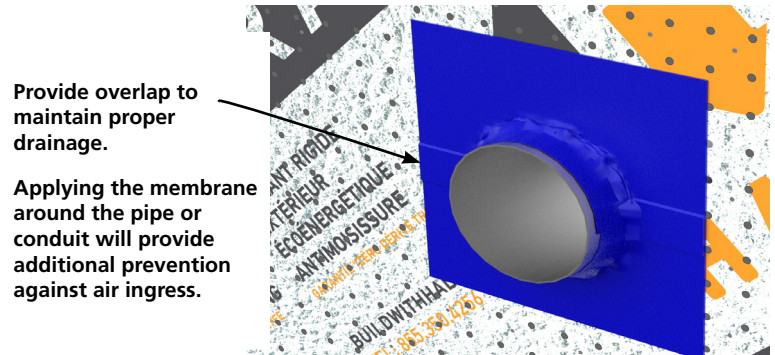

Step 5: Apply sheathing tape.

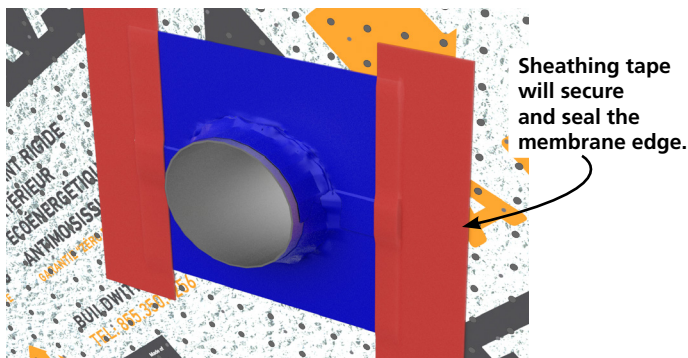

Step 6: Install trim block.

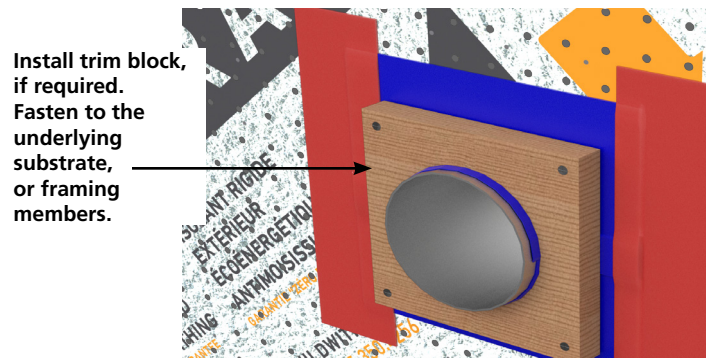

Step 7: Install flashing.

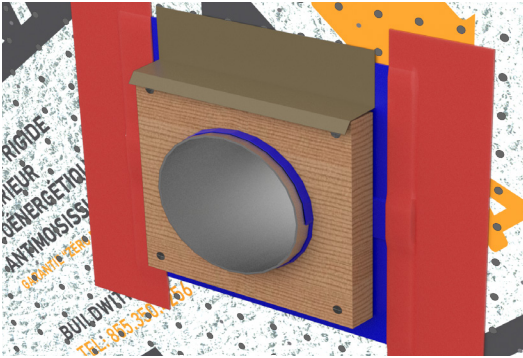

Step 8: Apply sheathing tape to seal edge of membrane and flashing.

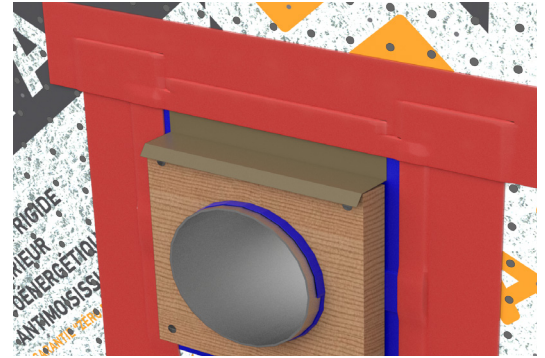

Step 9: Fasten cover to trim block.

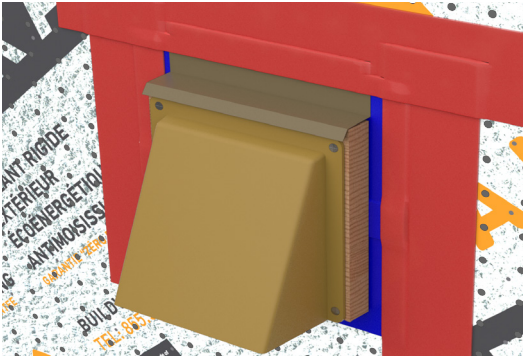

5.6.2 - OPENINGS

The following illustrations provide a typical example of addressing proper drainage and insulation around a flanged window. Refer to Section 10 for additional window opening details.

Step 1: After cutting a section of Exterra to match the rough opening, install a self-adhering flashing membrane at the sill.

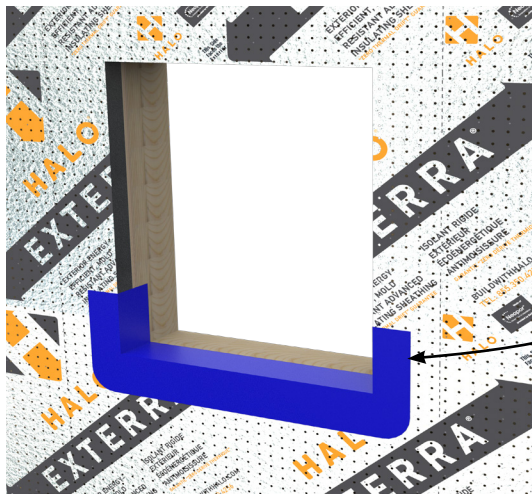

Install a vertical section of the membrane a minimum of 8" up the jamb.

Step 2: Install a self-adhering membrane along the length of the jam.

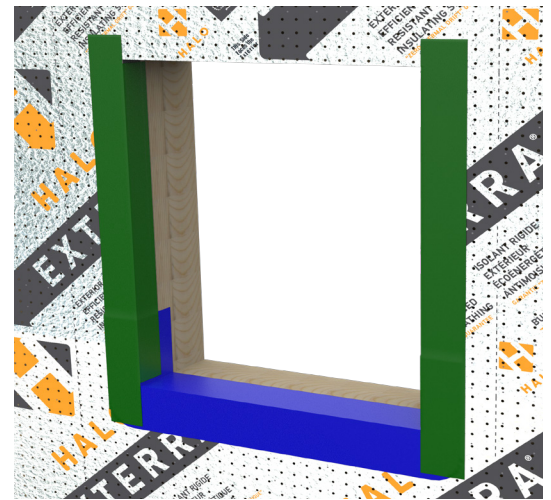

Step 3: Install the flanged window and fasten to the substrate.

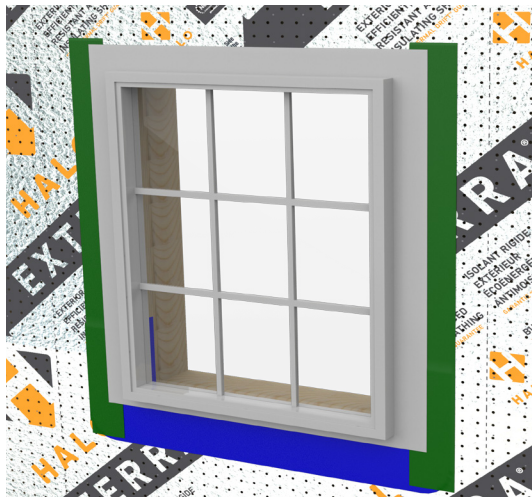

Step 4: Install a self-adhering membrane along the length of the jam over the flanges.

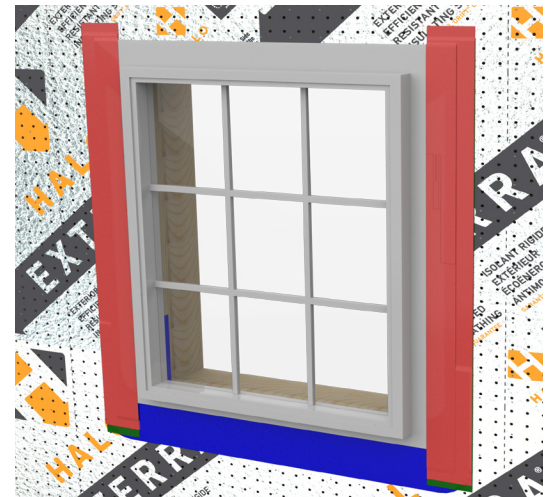

Step 5: Install the head flashing.

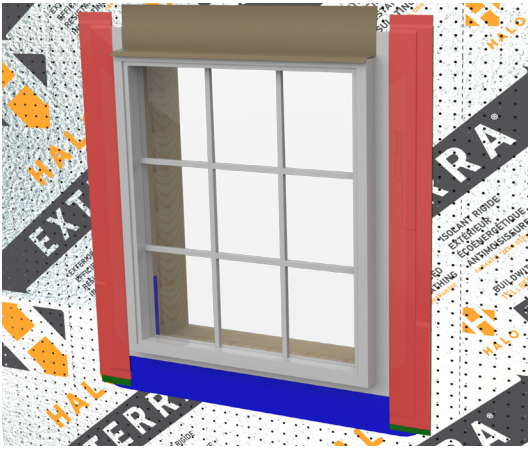

Step 6: Install a self-adhering membrane over the flashing.

Apply sheathing tape lapped over the membrane.

Self-adhering membrane should completely lap the membranes at the jambs.



Step 7: if required, install furring strips around the opening.

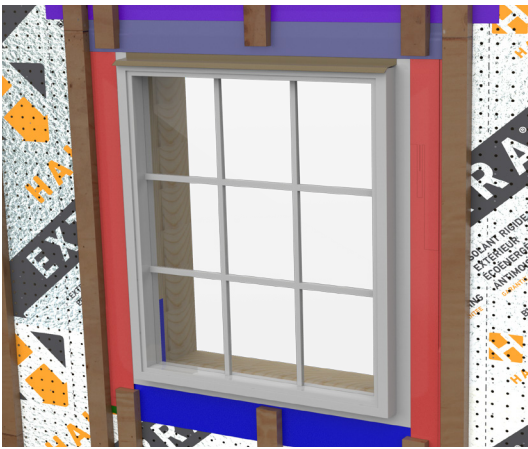

Step 8: Install trim boards and fasten to the furring strips or substrate.

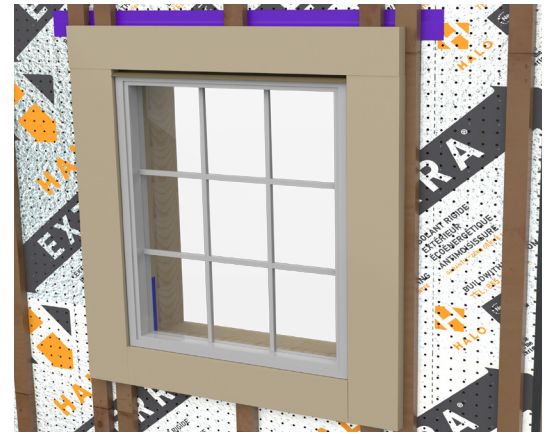

Step 9: Install cladding, as required.

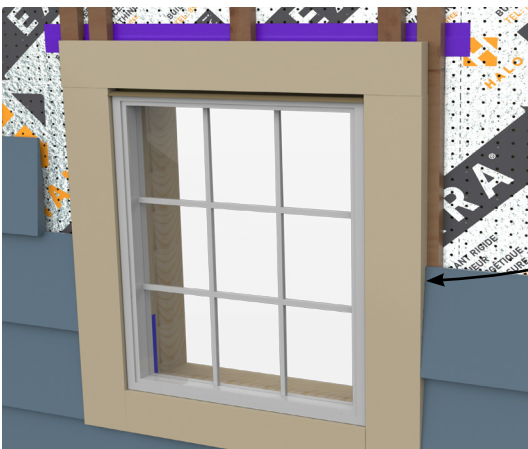

Apply a compatible sealant between cladding and trim boards.

Apply spray foam between rough opening and window.

Step 10: Apply spray foam.



5.7 - CLADDING

Cladding and wood strapping can be installed directly over Exterra with the use of fasteners.

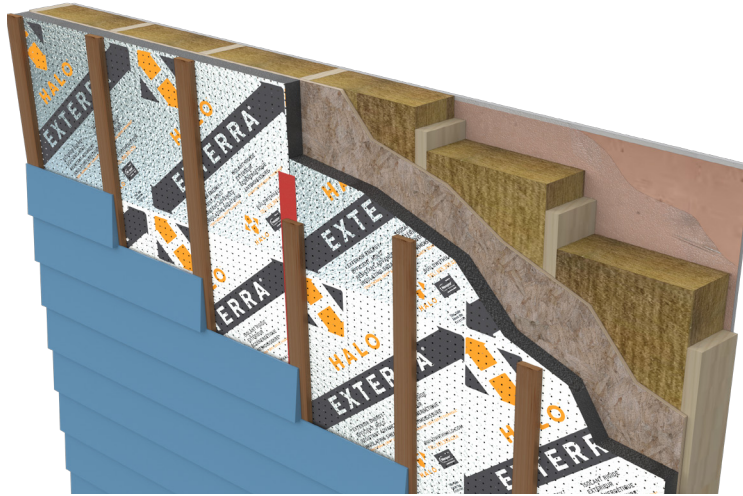

Fasten cladding to the substrate, or if required to the wood furring strips. See Section 8 for fastening information.

5.8 - CAVITY WALLS

Fasten Exterra directly to the wall substrate using appropriate fasteners.

There are a number of available brick ties designed to be compatible for foam sheathing. Below is a list of compatible brick ties.

Fasteners for brick ties must penetrate the Exterra layer and at least 3/4" into the wall substrate.

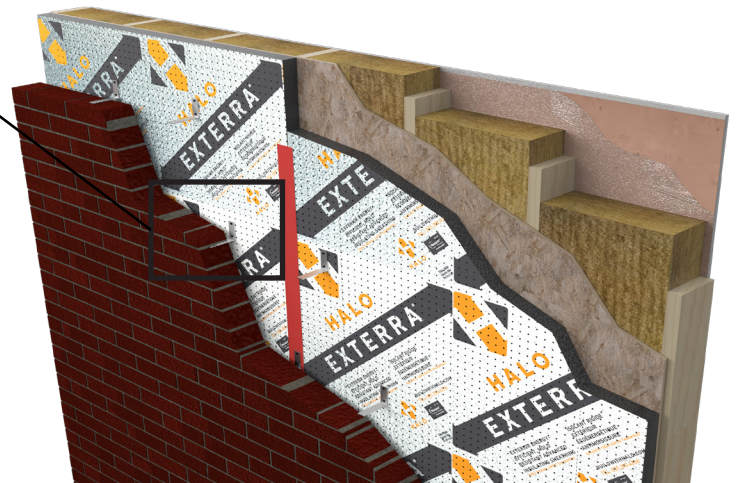
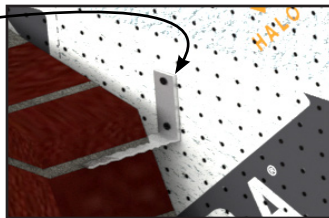

- Slotted Stud Tie, Fero Corp., ferocorp.com
- Pos-i-Tie, Heckmann Building Products, heckmannbuildingprods.com
- X-Seal Anchor, Hohmann & Barnard, H-b.com
- Dur-O-Wal Veneer Anchors, Dayton Superior, daytonsuperior.com.



HALO® EXTERRA® EXTERIOR RIGID INSULATION

6.0 – FASTENING EXTERRA

This section is a guide to fastening cladding or wood strapping over Halo Exterra.

Exterra is not structural so a minimal number of fasteners is required to tack Exterra sheets in place – the attachment of cladding, strapping, and housewrap will fully secure sheets.

For framed walls fasten Exterra sheets at the corner edges. The top of the fasteners should be flush to the surface of the sheets.

6.1 - TYPICAL FASTENER TYPES

Typical fastener types include, but not limited to:

- Plastic cap nails,
- roofing nails with at least 1/2" diameter washers,
- cap staples,
- or wood screws with metal roof washers.

When fastening to metal studs use screws with at least 1" diameter metal washers.

6.2 - OVER WOOD SHEATHING

Fasteners should be long enough to penetrate Exterra and completely through the wood sheathing substrate.

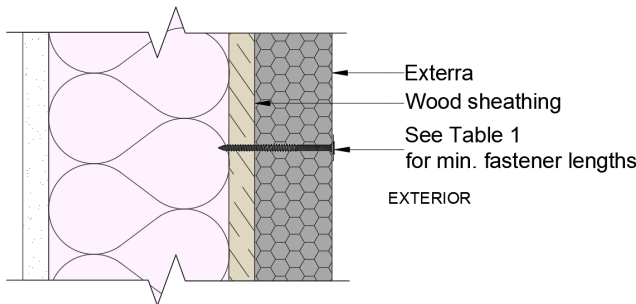

Table 1: Exterra Fastened to Wood Sheathing

Exterra Thickness	Minimum Fastener Lengths		
	1/2" Wood Sheathing	5/8" Wood Sheathing	3/4" Wood Sheathing
9/16" or 5/8"	1 1/8"	1 1/4"	1 3/8"
1"	1 1/2"	1 5/8"	1 3/4"
1 1/2"	2"	2 1/8"	2 1/4"
2"	2 1/2"	2 5/8"	2 3/4"

6.3 - OVER WOOD FRAMING STUDS

Fasteners should be long enough to penetrate Exterra and at least 3/4" into the framing studs or blocking between studs.

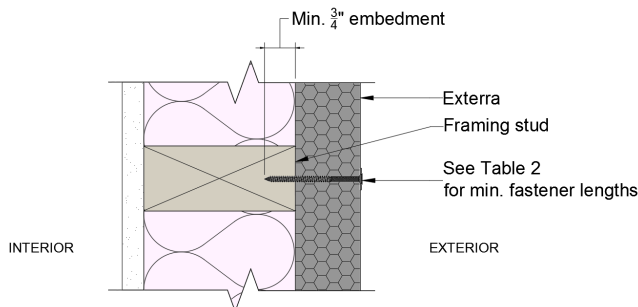

Table 2: Exterra Fastened Direct to Framing Studs

Exterra Thickness	Minimum Fastener Lengths
9/16" or 5/8"	1 3/8"
1"	1 3/4"
1 1/2"	2 1/4"
2"	2 3/4"



6.4 - OVER CONCRETE OR MASONRY WALLS

Use weather resistant construction glue compatible with expanded polystyrene, such as PL 300, to secure Exterra sheets to the wall. If the wall is too rough or uneven concrete screws with washers can be used along with adhesives to help secure the sheets.

If concrete screws are used place sheathing tape over the screws to maintain the water resistive barrier properties of Exterra

Use weather resistant construction glue compatible with EPS, such as PL 300, to secure Exterra to the wall.

If the wall is too rough or uneven concrete screws with washers can be used along with adhesives to help secure Exterra.

Remove any protrusions that can damage or prevent Exterra from laying flat against the wall.

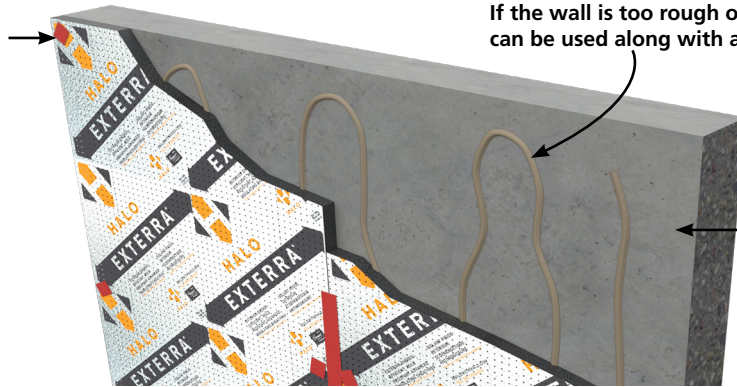

6.5 - CAVITY WALLS

For cavity walls, Exterra will either be placed over wood, concrete or masonry substrates. Refer to Sections 6.2 to 6.4 for appropriate fastening requirements.

HALO® EXTERRA® EXTERIOR RIGID INSULATION

7.0 - INSPECTION & REPAIRS

Exterra is designed to be durable and flexible. However, inspecting the condition of installed Exterra boards prior to the attachment of cladding or strapping will ensure Exterra performs as designed.

Inspect installed Exterra boards sufficiently in advance of cladding or strapping placement to ensure

- taped seams are not broken
- joints, penetrations and perimeter are properly sealed
- damaged areas are marked and properly repaired.

In most cases repairing damaged Exterra boards simply requires tape sealing over the damaged area. If the foam and laminate are damaged then removing the damaged section and replacing with a new section will be required.

INSTALLATION GUIDE

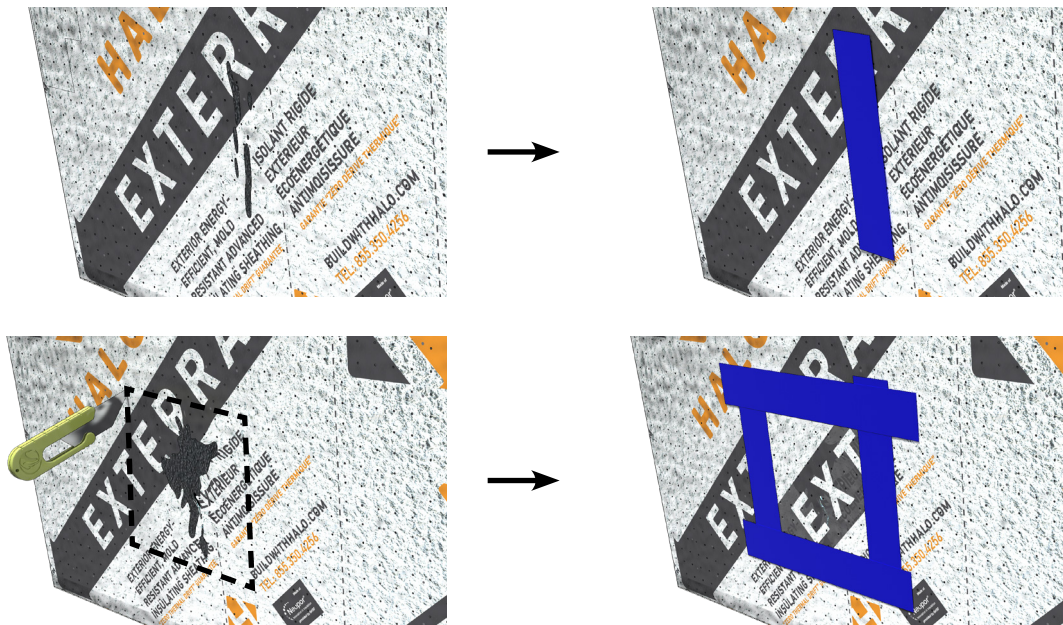

8.0 - CLADDING OVER EXTERRA

This section is a guide to fastening cladding or wood strapping over Halo Exterra.

8.1 - CLADDING OVER EXTERRA WITHOUT WOOD STRAPPING

When cladding is attached without wood strapping, nails or screws used to attach cladding directly over Exterra should penetrate Exterra and completely through the wood sheathing. The thickness of the wood sheathing should be structurally adequate to resist the lateral and pull-out loads the cladding may be subjected to. Check with your local cladding supplier to confirm.

In cases where wood sheathing is not present, or will not provide adequate strength, the fasteners should be fastened into the framing members. The nails or screws should penetrate Exterra and at least 1" into the framing studs, or blocking between framing studs.

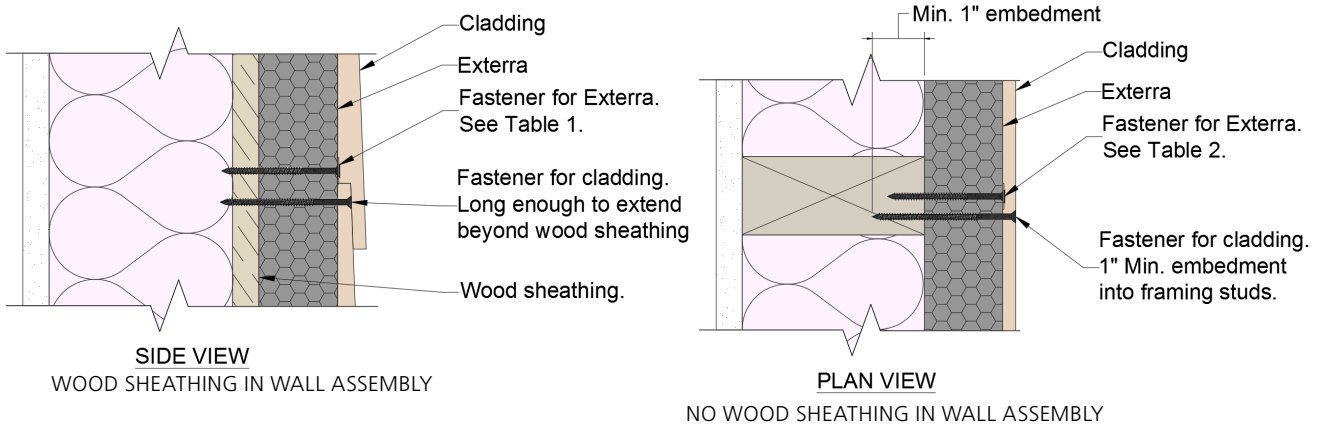

8.2 - CLADDING OVER EXTERRA WITH WOOD STRAPPING

When using wood strapping over Exterra, the cladding will be fastened to the strapping.

1. Wood Strapping Size:
Minimum ¾" thick. 1 x 3 strapping is recommended.
2. Wood Strapping Location:
Place vertically or horizontally, as required, and should be spaced a maximum of 16" on center. If placing vertically, align the strapping to the framing studs.
3. Fastener Types:
Use #8 or #10 non-corrosive wood screws spaced maximum 16" on center.
4. Fastener Length:
Screws should be long enough to penetrate wood strapping, Exterra, and at least 1" into the framing studs.
5. Attach cladding to wood strapping. Ensure the nails or screws fully penetrate the strapping.

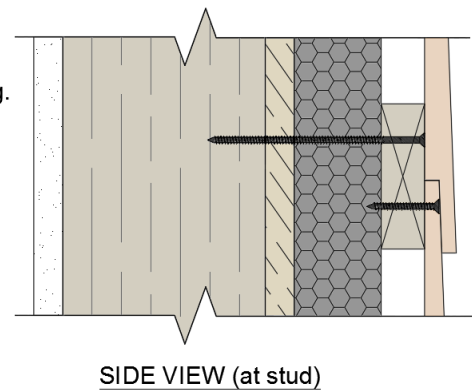
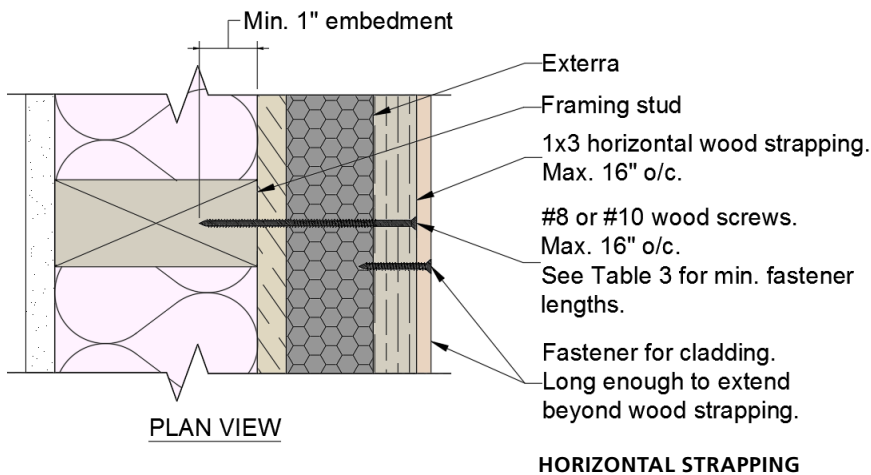
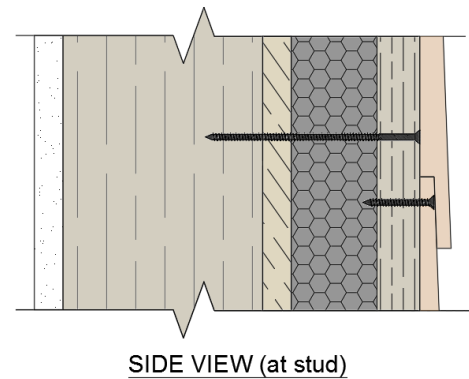
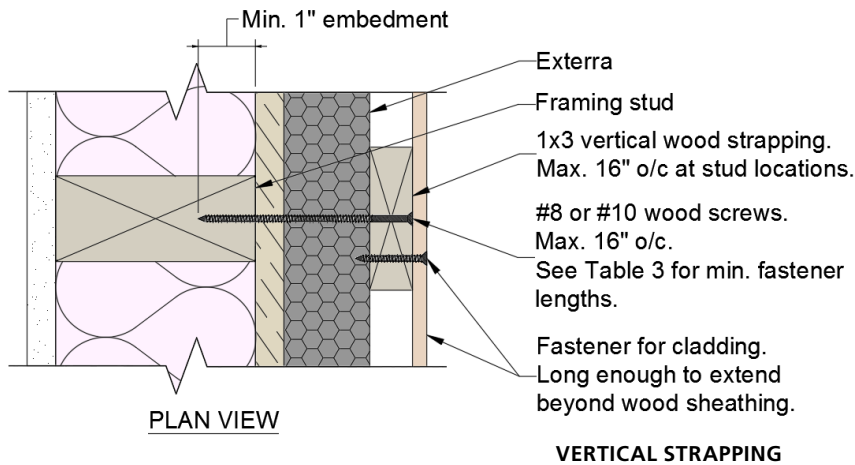

Table 3: 1x3 Wood Strapping Over Exterra

Exterra Thickness	Minimum Fastener Lengths		
	1/2" Wood Sheathing	5/8" Wood Sheathing	3/4" Wood Sheathing
9/16" or 5/8"	2 7/8"	3"	3 1/8"
1"	3 1/4"	3 3/8"	3 1/2"
1 1/2"	3 3/4"	3 7/8"	4"
2"	4 1/4"	4 3/8"	4 1/2"

9.0 - AIR BARRIER

Exterra wall assemblies require a separate air barrier system. The air barrier system can be from the exterior, interior, or anywhere in between as long as the continuity of the air barrier system is maintained.

Since 6 mil polyethylene membranes are typically required as the controlling vapor barrier for exterior wall assemblies, it can also provide the controlling air barrier. The following illustrations are examples of a polyethylene air barrier approach for Exterra wall assemblies. Careful attention should be paid to transitions and penetrations.

9.1 - ROOF/CEILING TRANSITION

Lap the 6 mil poly membranes in the ceiling and walls with vapor barrier sheathing tape.

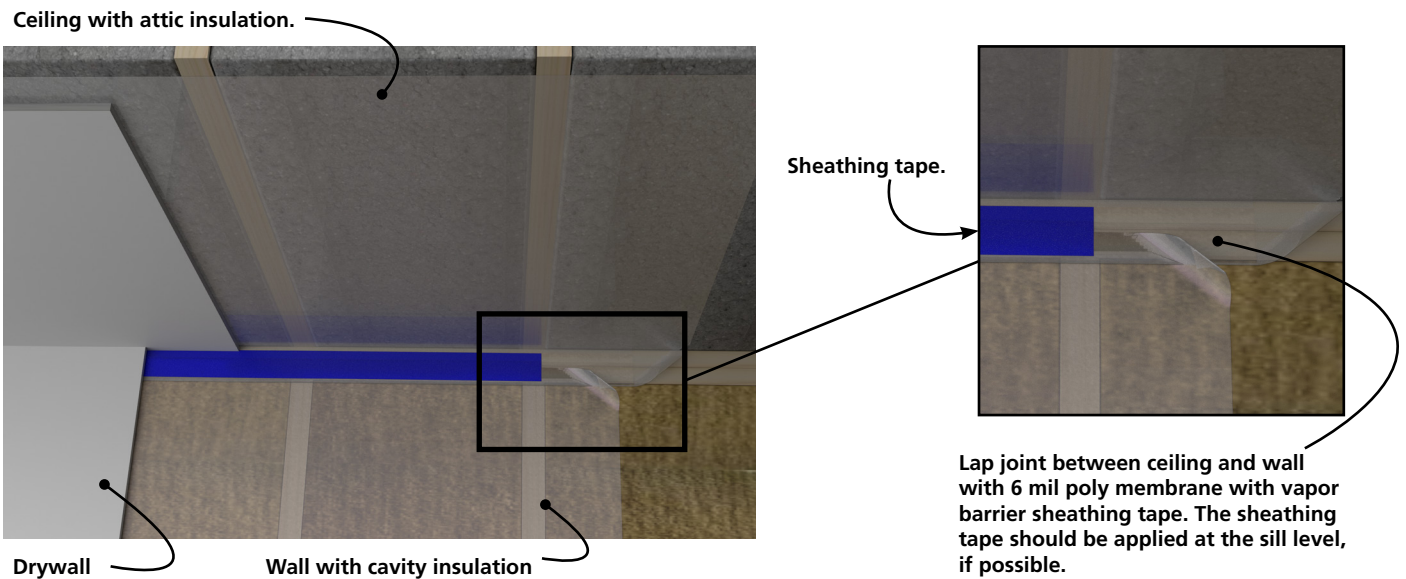

9.2 - WALL PERIMETER AND RIM BOARDS

Seal the 6 mil poly membrane to the framing members. Install rigid insulation against the rim board between floor joists. The insulation should be sealed to maintain the air barrier, and thick enough to act as a vapor/air barrier.

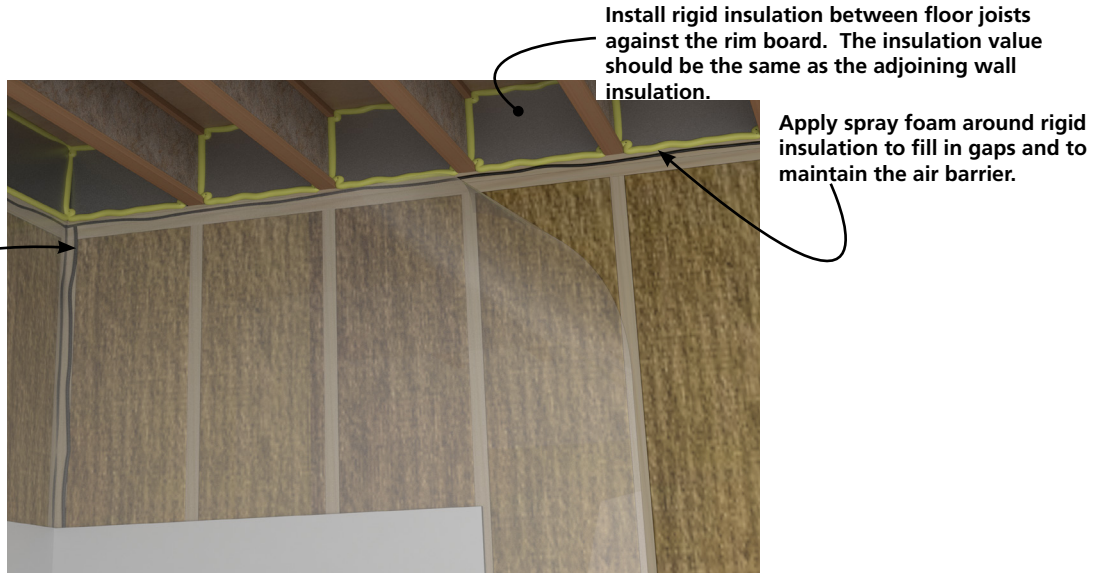

9.3 - FOUNDATION

Install rigid insulation against the rim board between floor joists. The insulation should be sealed to maintain the air barrier. A sealant should also be applied between the sill and top of foundation wall.

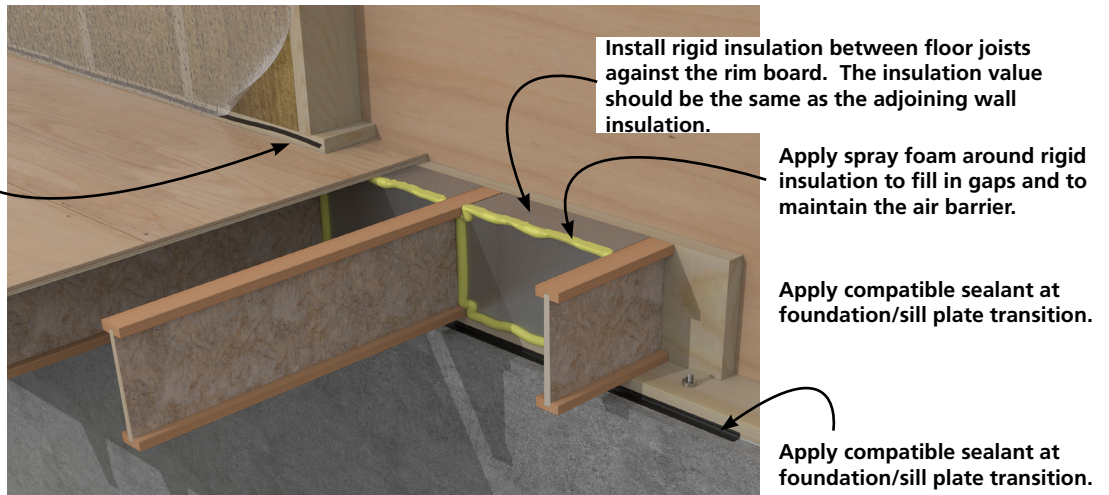

9.4 - PENETRATIONS

Providing a section of plywood sheathing around the penetration provides the required solid backing for 6 mil poly members.

Attached a section of wood sheathing. Fasten to blocking and keep flush to face of studs.

This will provide a solid backing for the 6 mil poly around the opening and secures the duct, pipe or conduit in place when connecting additional sections.

6 mil poly membrane (partially shown).

Place over the acoustic sealant and staple in place. Staples should be applied over the acoustic sealant.

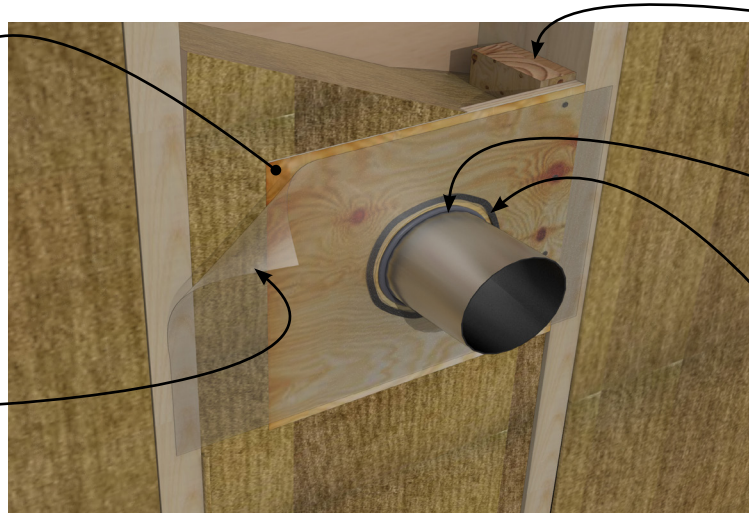

Wood blocking.

Compatible air barrier sealant applied around the duct, pipe or conduit.

Acoustic sealant.

9.5 - INTERIOR ELECTRICAL RECEPTACLES

Vapor/air barrier polyethylene boots should be used to maintain the air barrier around electrical receptacles.

Fasten wood blocking to stud. This will provide a solid backing for the vapor barrier boot.

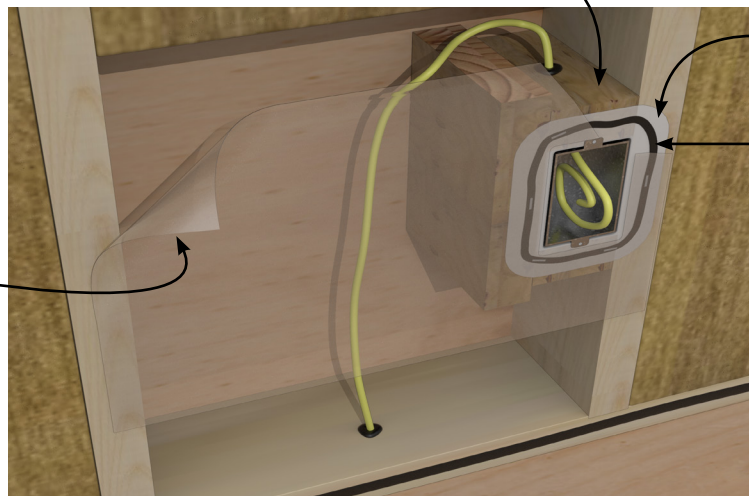

Vapor/air barrier boot.

Apply acoustic sealant around the vapor/air barrier boot.

6 mil poly membrane (partially shown).

Place over the acoustic sealant and staple in place. Staples should be applied over the acoustic sealant.

10.0 - EXAMPLE CAD DETAILS

THE DRAWINGS REPRESENTED HEREIN ARE BELIEVED TO BE ACCURATE AND CONFORMING TO CURRENT DESIGN AND CONSTRUCTION PRACTICES. HOWEVER, THE DRAWINGS SHOULD BE USED AS A REFERENCE GUIDE ONLY. THE USER SHALL CHECK TO ENSURE THE DRAWING MEETS LOCAL BUILDING CODES, DESIGN AND CONSTRUCTION PRACTICES BY CONSULTING LOCAL BUILDING OFFICIALS AND PROFESSIONALS, INCLUDING ANY ADDITIONAL REQUIREMENTS. HALO RESERVES THE RIGHT TO MAKE CHANGES TO THE DRAWINGS WITHOUT NOTICE AND ASSUMES NO LIABILITY IN CONNECTION WITH THE USE OF THE DRAWINGS INCLUDING MODIFICATION, COPYING OR DISTRIBUTION.

HALO® EXTERRA® EXTERIOR RIGID INSULATION

10.1 - FLANGED WINDOW INSTALLED AGAINST WOOD SHEATHING

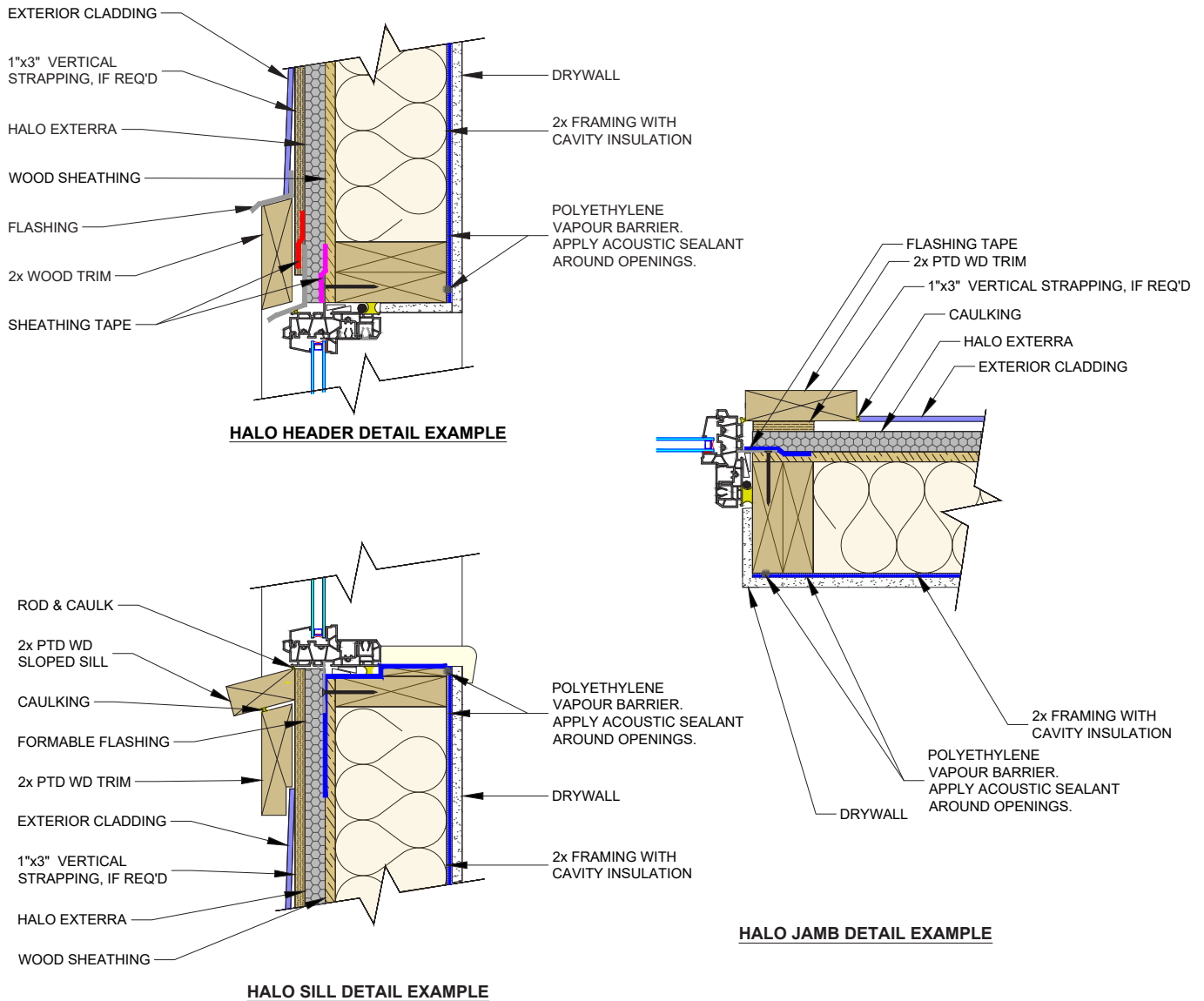

INSTALLATION GUIDE

The tables and drawings represented herein are believed to be accurate and conforming to current design and construction practices. However, the tables and drawings should be used as a reference guide only. The user shall check to ensure the drawing meets local building codes, design and construction practices by consulting local building officials and professionals, including any additional requirements. Logix reserves the right to make changes to the tables and drawings without notice and assumes no liability in connection with the use of the tables and drawings including modification, copying or distribution.



HALO® EXTERRA® EXTERIOR RIGID INSULATION

10.2 - FLANGED WINDOW INSTALLED AGAINST EXTERRA

INSTALLATION GUIDE

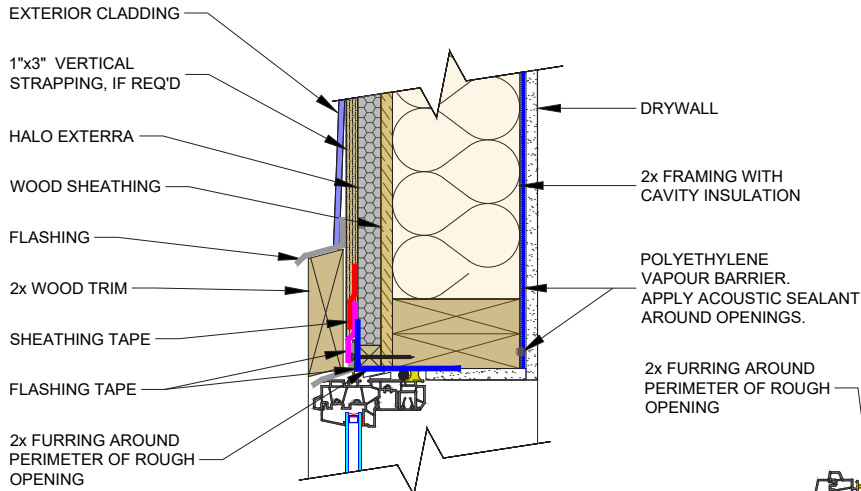

HALO HEADER DETAIL EXAMPLE

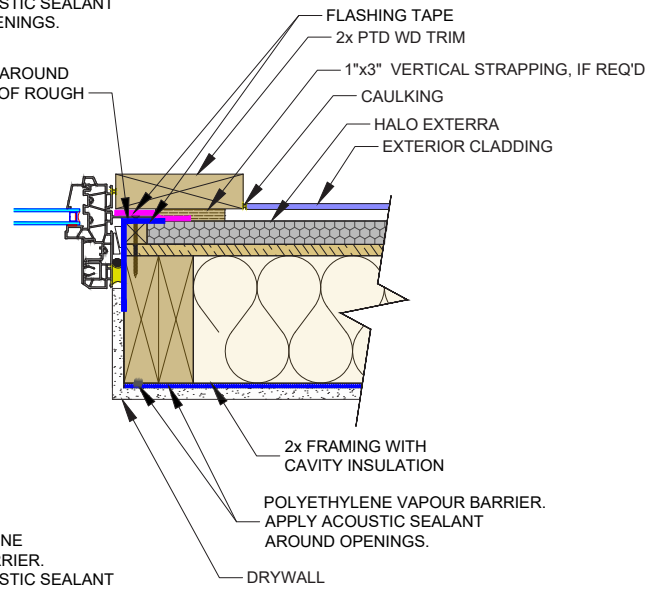

HALO JAMB DETAIL EXAMPLE

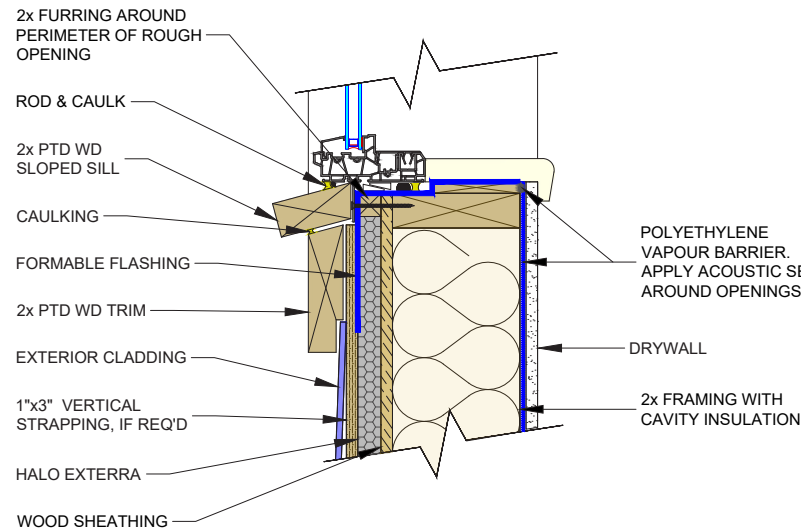

HALO SILL DETAIL EXAMPLE

The tables and drawings represented herein are believed to be accurate and conforming to current design and construction practices. However, the tables and drawings should be used as a reference guide only. The user shall check to ensure the drawing meets local building codes, design and construction practices by consulting local building officials and professionals, including any additional requirements. Logix reserves the right to make changes to the tables and drawings without notice and assumes no liability in connection with the use of the tables and drawings including modification, copying or distribution.



HALO® EXTERRA® EXTERIOR RIGID INSULATION

10.3 - ROOF TRANSITION

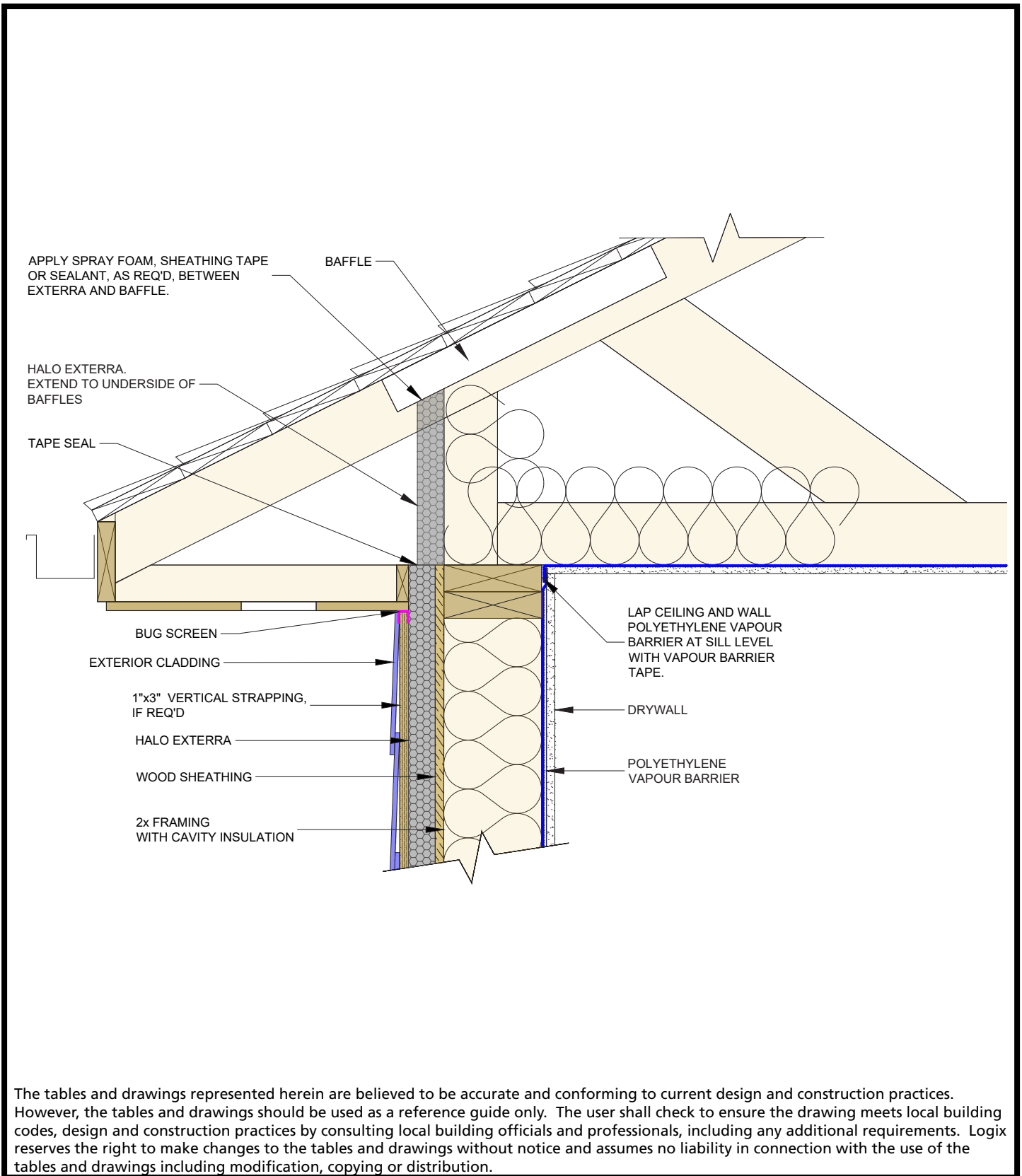

HALO® EXTERRA® EXTERIOR RIGID INSULATION

10.4 - TYPICAL WALL ASSEMBLY

INSTALLATION GUIDE

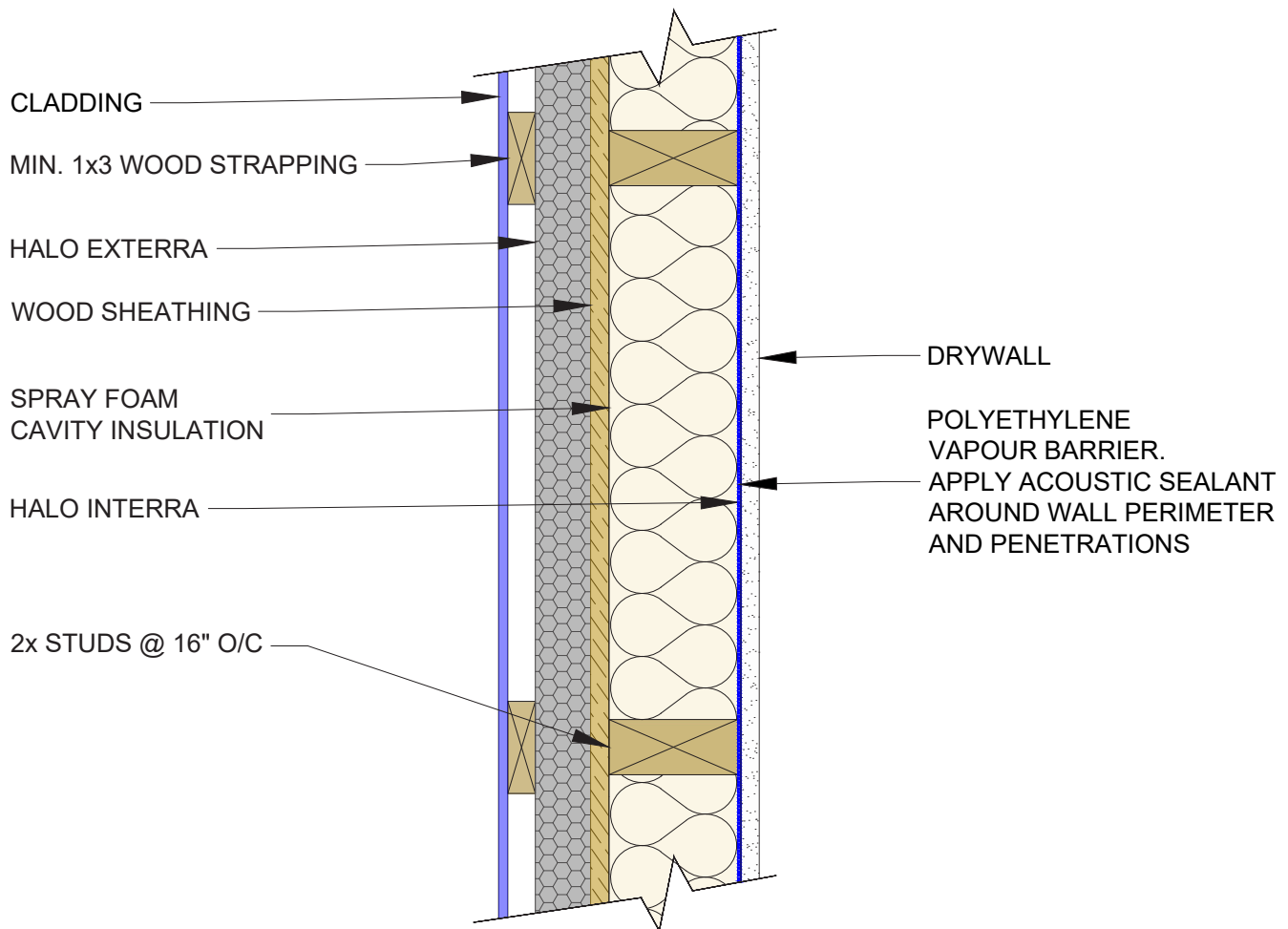

The tables and drawings represented herein are believed to be accurate and conforming to current design and construction practices. However, the tables and drawings should be used as a reference guide only. The user shall check to ensure the drawing meets local building codes, design and construction practices by consulting local building officials and professionals, including any additional requirements. Logix reserves the right to make changes to the tables and drawings without notice and assumes no liability in connection with the use of the tables and drawings including modification, copying or distribution.



HALO® EXTERRA® EXTERIOR RIGID INSULATION

10.5 - FLOOR TRANSITION

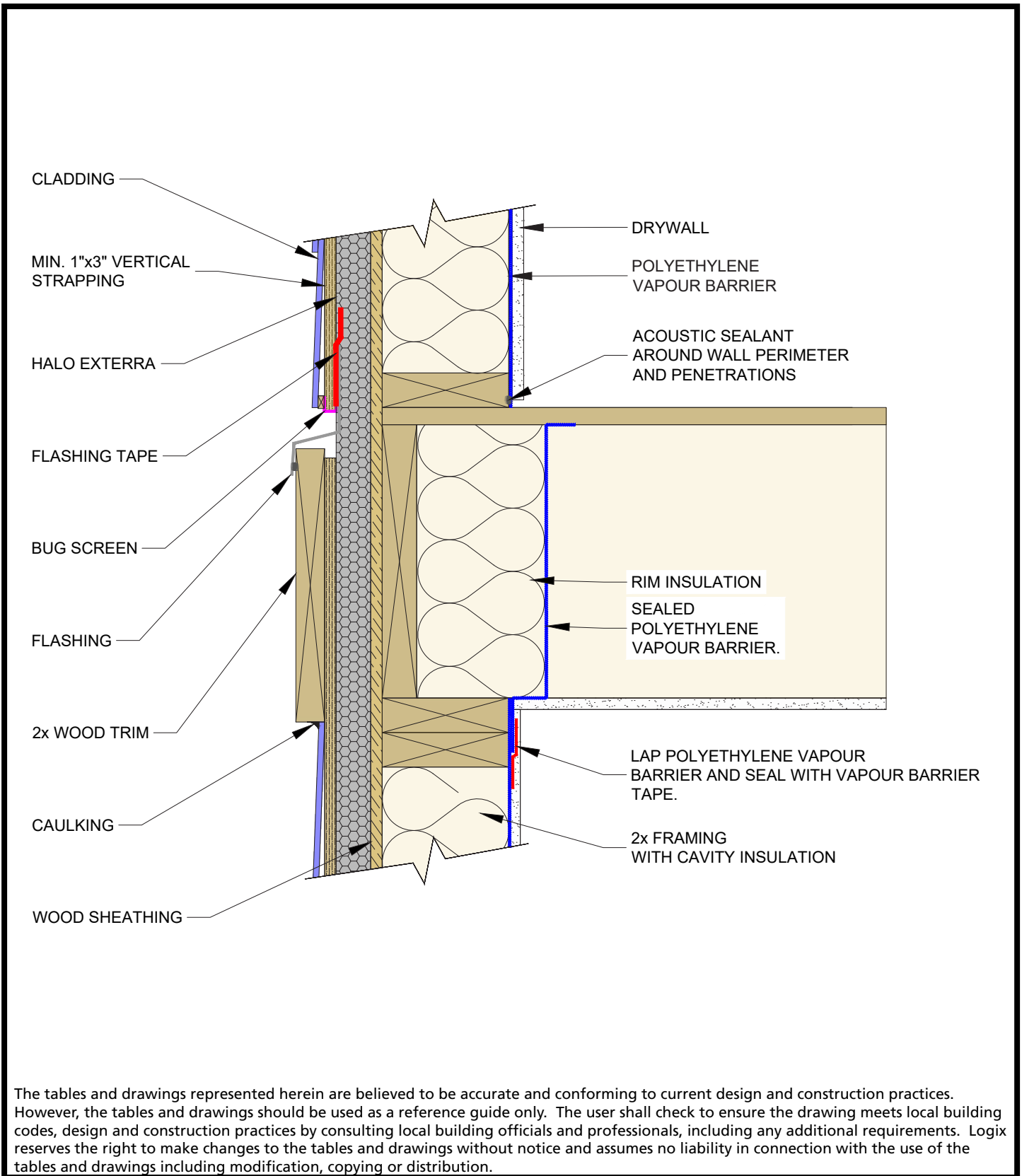

The tables and drawings represented herein are believed to be accurate and conforming to current design and construction practices. However, the tables and drawings should be used as a reference guide only. The user shall check to ensure the drawing meets local building codes, design and construction practices by consulting local building officials and professionals, including any additional requirements. Logix reserves the right to make changes to the tables and drawings without notice and assumes no liability in connection with the use of the tables and drawings including modification, copying or distribution.



HALO® EXTERRA® EXTERIOR RIGID INSULATION

10.6 - FOUNDATION TRANSITION

INSTALLATION GUIDE

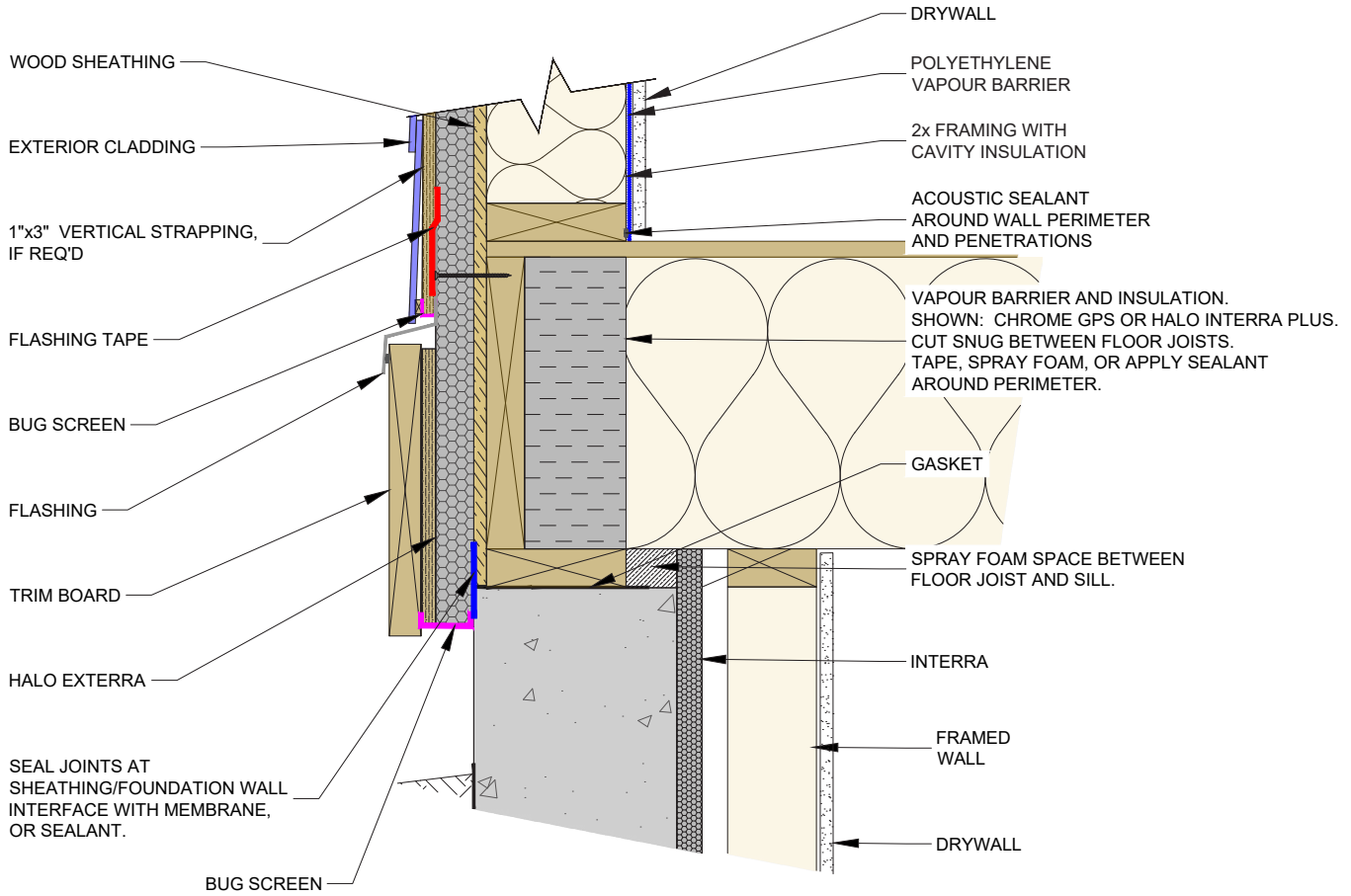

The tables and drawings represented herein are believed to be accurate and conforming to current design and construction practices. However, the tables and drawings should be used as a reference guide only. The user shall check to ensure the drawing meets local building codes, design and construction practices by consulting local building officials and professionals, including any additional requirements. Logix reserves the right to make changes to the tables and drawings without notice and assumes no liability in connection with the use of the tables and drawings including modification, copying or distribution.





CONNECT WITH A LOCAL MANUFACTURER

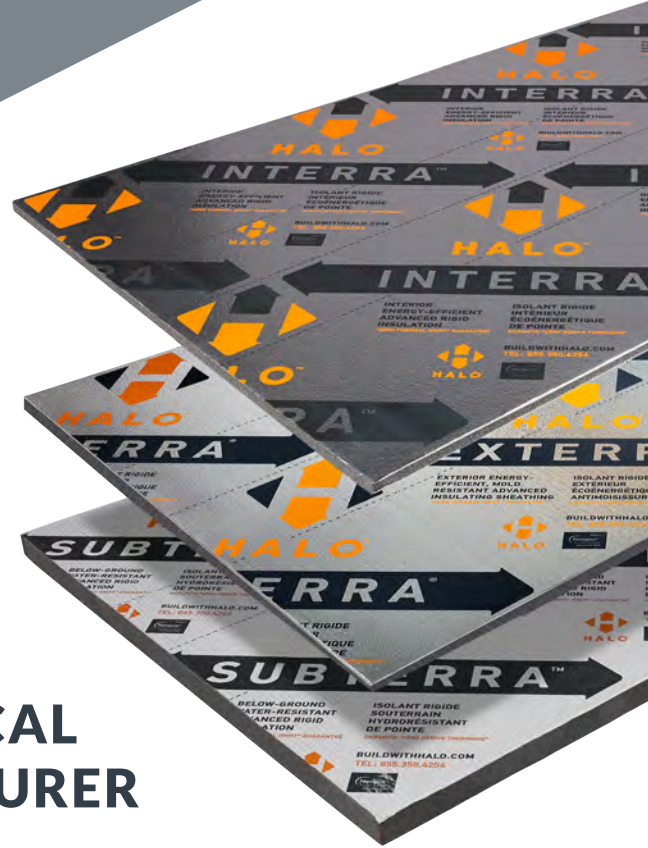

888.838.5038
330 Cain Drive
Haysville, KS 67060-2004

800.860.3626
6753 Chestnut Ridge Rd.
Beach City, OH 44608

800.647.6130
2604 Sunset Dr.
Grenada, MS 38901

800.647.6130
106 Perma R Rd.
Johnson City, TN 37604

888.706.7709
840 Division St.
Cobourg, ON K9A 5V2

877.789.7622
35 Headingley Rd.
Headingley, MB R4H 0A8

888.453.5961
11581-272 St.
Acheson, AB T7X 6E9

888.453.5961
6333 Unsworth Rd.
Chilliwack, BC V2R 5M3



HALO[®]
ADVANCED GRAPHITE INSULATION SYSTEM

855-350-4256 (Halo)
info@BuildWithHalo.com
BuildWithHalo.com

A Product By
LOGIX[®]
BRANDS